

User Manual

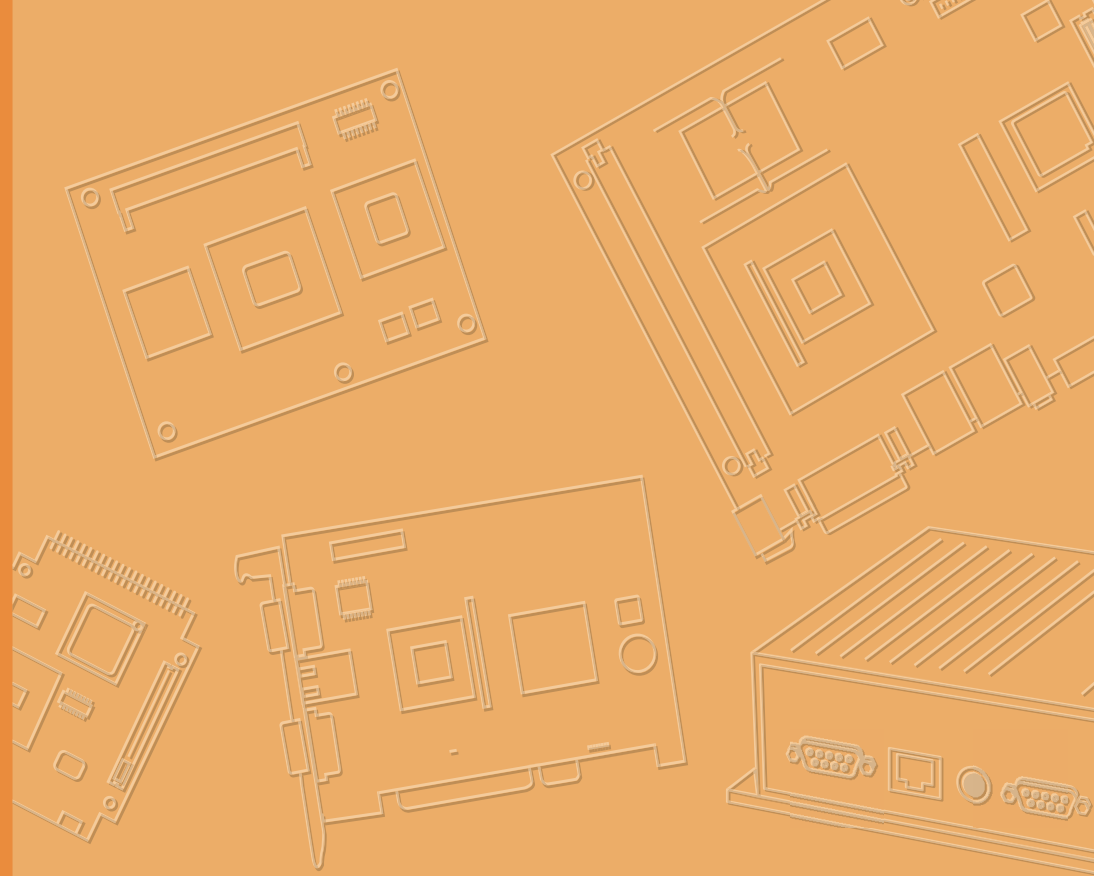

UTC-315

**Intel® Platform Processor-
based Ubiquitous Touch
Computer with 15.6" TFT LCD**

ADVANTECH

Enabling an Intelligent Planet

Copyright

The documentation and the software included with this product are copyrighted 2021 by Advantech Co., Ltd. All rights are reserved. Advantech Co., Ltd. reserves the right to make improvements in the products described in this manual at any time without notice. No part of this manual may be reproduced, copied, translated or transmitted in any form or by any means without the prior written permission of Advantech Co., Ltd. Information provided in this manual is intended to be accurate and reliable. However, Advantech Co., Ltd. assumes no responsibility for its use, nor for any infringements of the rights of third parties, which may result from its use.

Acknowledgements

Award is a trademark of Award Software International, Inc. Intel® and Celeron® are trademarks of Intel Corporation.

IBM, PC/AT, PS/2 and VGA are trademarks of International Business Machines Corporation.

Intel® and Pentium® are trademarks of Intel Corporation.

Microsoft Windows® is a registered trademark of Microsoft Corp. RTL is a trademark of Realtek Semiconductor Co., Ltd.

All other product names or trademarks are properties of their respective owners.

For more information on this and other Advantech products, please visit our websites at:

<http://www.advantech.com>

For technical support and service, please visit our support website at:

<http://support.advantech.com>

This manual is for the UTC-315.

Declaration of Conformity

FCC Class A

Note: This equipment has been tested and found to comply with the limits for a Class B digital device, pursuant to part 15 of the FCC Rules. These limits are designed to provide reasonable protection against harmful interference in a residential installation. This equipment generates, uses and can radiate radio frequency energy and, if not installed and used in accordance with the instructions, may cause harmful interference to radio communications. However, there is no guarantee that interference will not occur in a particular installation. If this equipment does cause harmful interference to radio or television reception, which can be determined by turning the equipment off and on, the user is encouraged to try to correct the interference by one or more of the following measures:

- Reorient or relocate the receiving antenna.
- Increase the separation between the equipment and receiver.
- Connect the equipment into an outlet on a circuit different from that to which the receiver is connected.
- Consult the dealer or an experienced radio/TV technician for help.

Warning! *Any changes or modifications made to the equipment which are not expressly approved by the relevant standards authority could void your authority to operate the equipment.*



- Replacement of a BATTERY with an incorrect type that can defeat a SAFE-GUARD (for example, in the case of some lithium BATTERY types).
- Disposal of a BATTERY into fire or a hot oven, or mechanically crushing or cutting of a BATTERY, that can result in an explosion.
- Ensure to connect the power cord to a socket-outlet with earthing connection.

Packing List

Before you begin installing UTC-315, please make sure that the following materials have been shipped:

- UTC-315 series
- Accessories for UTC-315
 - Warranty card
 - 1 x adapter
 - 1 x SATA cable
 - Packet of screws

If any of these items are missing or damaged, contact your distributor or sales representative immediately.

Technical Support and Assistance

1. Visit the Advantech web site at <http://support.advantech.com> where you can find the latest information about the product.
2. Contact your distributor, sales representative, or Advantech's customer service center for technical support if you need additional assistance. Please have the following information ready before you call:
 - Product name and serial number
 - Description of your peripheral attachments
 - Description of your software (operating system, version, application software, etc.)
 - A complete description of the problem
 - The exact wording of any error messages

Safety Instructions

1. Read these safety instructions carefully.
2. Keep this User Manual for later reference.
3. Disconnect this equipment from any AC outlet before cleaning. Use a damp cloth. Do not use liquid or spray detergents for cleaning.
4. For plug-in equipment, the power outlet socket must be located near the equipment and must be easily accessible.
5. Keep this equipment away from humidity.
6. Put this equipment on a reliable surface during installation. Dropping it or letting it fall may cause damage.
7. The openings on the enclosure are for air convection. Protect the equipment from overheating. **DO NOT COVER THE OPENINGS.**
8. Make sure the voltage of the power source is correct before connecting the equipment to the power outlet.
9. Position the power cord so that people cannot step on it. Do not place anything over the power cord.
10. All cautions and warnings on the equipment should be noted.
11. If the equipment is not used for a long time, disconnect it from the power source to avoid damage by transient overvoltage.
12. Never pour any liquid into an opening in the device. This may cause fire or electrical shock.
13. Never open the equipment. For safety reasons, the equipment should be opened only by qualified service personnel.
14. If one of the following situations arises, get the equipment checked by service personnel:
 - The power cord or plug is damaged.
 - Liquid has penetrated into the equipment.
 - The equipment has been exposed to moisture.
 - The equipment does not work well, or you cannot get it to work according to the user's manual.
 - The equipment has been dropped and damaged.
 - The equipment has obvious signs of breakage.
15. **DO NOT LEAVE THIS EQUIPMENT IN AN ENVIRONMENT WHERE THE STORAGE TEMPERATURE MAY GO BELOW -20° C (-4° F) OR ABOVE 60° C (140° F). THIS COULD DAMAGE THE EQUIPMENT. THE EQUIPMENT SHOULD BE IN A CONTROLLED ENVIRONMENT.**
16. **CAUTION: DANGER OF EXPLOSION IF BATTERY IS INCORRECTLY REPLACED. REPLACE ONLY WITH THE SAME OR EQUIVALENT TYPE RECOMMENDED BY THE MANUFACTURER, DISCARD USED BATTERIES ACCORDING TO THE MANUFACTURER'S INSTRUCTIONS.**
17. The sound pressure level at the operator's position according to IEC 704-1:1982 is no more than 70 dB (A).

DISCLAIMER: This set of instructions is given according to IEC 704-1. Advantech disclaims all responsibility for the accuracy of any statements contained herein.

Contents

Chapter 1	General Information	1
1.1	Introduction	2
1.2	General Specifications	2
1.2.1	General	2
1.2.2	Standard PC Functions	2
1.2.3	Audio Function	3
1.2.4	LAN Function	3
1.2.5	Touch Screen (Optional)	3
1.2.6	Environment	3
1.3	LCD Specifications	4
1.4	Optional modules	4
1.5	Dimensions	5
	Figure 1.1 Dimensions of UTC-315	5
Chapter 2	System Setup	7
2.1	A Quick Tour of the UTC-315	8
	Figure 2.1 Front view of UTC-315	8
	Figure 2.2 Rear view of UTC-315	8
2.2	Installation Procedures	10
2.2.1	Connecting the power cord	10
2.2.2	Connecting the keyboard or mouse	10
2.2.3	Switching on the power	10
	Figure 2.3 Connect the power cord to the DC inlet	10
2.3	Running the BIOS Setup Program	11
2.4	Installing System Software	13
2.4.1	Method 1: Ethernet	13
2.4.2	Method 2: External USB CD-ROM	13
2.5	Installing the Drivers	13
Chapter 3	Hardware Installation and Upgrades	15
3.1	Introduction	16
3.2	Installing the 2.5" Hard Disk Drive (HDD)	16
	Figure 3.1 Installing primary 2.5" HDD	16
3.3	Installing the mSATA/m.2 Card	17
	Figure 3.2 Installing the mSATA/m.2 Card	17
3.4	Installing the WLAN	18
Chapter 4	Jumper and Connector Settings	21
4.1	Jumpers and Connectors	22
4.1.1	Setting Jumpers	22
4.1.2	Jumpers and Connectors	23
	Table 4.1: Jumper and Connector Functions	23
4.1.3	Locating Jumpers and Connectors	24
4.2	Jumpers	27
4.2.1	Jumper List	27
	Table 4.2: Jumper List	27
4.2.2	Jumper Settings	27

Table 4.3: P1(D),JP3(EF):LCD POWER	27
Table 4.4: JP1(H):PWM POWER.....	27
Table 4.5: JP2(H):BKLT Enable POWER	28
Table 4.6: JP3(D),JP6(E),JP5(F),JP4(G):Clear CMOS.....	28
Table 4.7: JP5(H):Clear CMOS	28
Table 4.8: JP4(H):TS POWER	29
Table 4.9: JP4(D),JP5(EG),JP7(F),JP8(H):AT/ATX POWER SEL	29
Table 4.10: CN17(D):COM1 Ring	29
Table 4.11: CN9(EF),CN14(G),CN18(H):COM1,COM2 Ring	30
Table 4.12: JCASH1: CASH DRAWER POWER SEL	30
Table 4.13: CN10: CSAFE Power	30

Appendix A I/O Pin Assignments 31

A.1 Pin Assignments	32
Table A.1: CN1(DE),CN2(FGH):Back Light.....	32
Table A.2: CN3(D):Internal USB.....	32
Table A.3: CN38(H),CN39(H):Internal USB.....	33
Table A.4: CN4(DEFG):LVDS	33
Table A.5: LVDS1(H):LVDS.....	35
Table A.6: CN5(D),CN3(EF),CN9(H):eDP	37
Table A.7: CN3(G) eDP	38
Table A.8: CN11(DF),CN10(G) VGA	39
Table A.9: SATA(DEFG):SATA	39
Table A.10:SATA1(H):SATA.....	40
Table A.11:CN7(D),CN3(EFG),CN25(H):SATA POWER	40
Table A.12:CN23(H):SATA LED	41
Table A.13:CN8(D),CN5(G):Internal USB	41
Table A.14:CN9(D),CN6(EG),CN26(F),CN41(H):Touch	42
Table A.15:CN13(D),DIMM(EG):DDR3L SODIMM	42
Table A.16:DIMM(F),CN1(H):DDR4 SODIMM	42
Table A.17:MINIPCIE1(DEF):MINIPCIE.....	43
Table A.18:MSATA1(DEFG):MSATA	45
Table A.19:CN14(D),CN10(F),CN7(GH):COM4	47
Table A.20:CN15(D) , CN12(F),CN9(G),CN96(H):COM3	47
Table A.21:CN11(E):CSAFE	48
Table A.22:CN16(D),CN13(E),CN14(F),CN11(G),CN44(H):COM2	48
Table A.23:CN18(D),CN14(E),CN15(F),CN13(GH):COM1	49
Table A.24:CN21(D),CN16(EF),CN23(G),CN45(H):Power on Switch	49
Table A.25:CN22(D),CN15(E),CN16(FG),CN168(H):SPEAKER	50
Table A.26:M.2_1(G):M.2_2230	50
Table A.27:CN16(H):M.2_2230	52
Table A.28:M2M1(H):M.2_2280	53
Table A.29:CN23(D),CN17(EFG):LAN1/LAN2	54
Table A.30:CN11(H):LAN1/LAN2	54
Table A.31:CN19(EF),CN21(G):External USB	55
Table A.32:CN20(EF),CN22(G):External USB	56
Table A.33:CN24,CN25 (D),CN18(EF),CN20(G):External USB	57
Table A.34:CN26(D):External USB.....	58
Table A.35:CN170(H),CN169(H),CN43(H):External USB	59
Table A.36:CN27(D),CN21(E),CN22(F),CN25(G),CN66(H):Line-out	60
Table A.37:CN28(D),CN22(E),CN21(F),CN24(GH):MIC-IN	60
Table A.38:CN30(D),CN24(EF),CN27(G),CN15(H):HDMI	61
Table A.39:CN42(H):DP	62
Table A.40:CN31(DG),CN25(EF),DCIN1(H):DC-IN	63

Table A.41:CN29(D),CN23(EF),CN26(G):RJ11	63
Table A.42:BUTTON:Power Button	64
Table A.43:CN45(H):Power Button.....	64
Table A.44:SW5(H):Power Button	64

Chapter 1

General Information

This chapter gives background information on the UTC-315.

Sections include:

- Introduction
- General Specifications
- LCD Specifications
- Dimensions

1.1 Introduction

UTC-315x is a multi-purpose all-in-one computing system equipped with a wide format, touch based LCD panel. It is easy to integrate key peripherals and display systems for diversified self-service and interactive signage deployed in different locations. With the removable frame, the system could also fulfill control system applications with its panel mounting design.

1.2 General Specifications

1.2.1 General

- **Dimensions:** 402 mm (L) x 260 mm (H) x 39.7 mm (D)
- **Weight:** 3.5 kg
- **Power adaptor:** AC/DC (Standard Build in) 12 V, 84 W
Input voltage: 100 ~ 240 V_{AC}
Output voltage: 12 V @ 7 A
- **Disk drive housing:** Space for one 2.5" SATA HDD
- **Front panel:** IP65

1.2.2 Standard PC Functions

- **CPU:**
 - Intel® Core™ i5-4300U (UTC-315E)/Core™ i5-6300U (UTC-315F) with 3 MB L3 cache/ Core™ i5-8365UE (UTC-315H) L3 Cache 3MB
 - Intel® Celeron® J1900 (UTC-315D)/ Pentium® N4200 (UTC-315G) with 2 MB L2 cache
- **BIOS:** AMI 16 MB Flash BIOS via SPI
- **System chipset:** Intel®Core™ i5-8365UE, Intel® Core™ i5-6300U, Core™ i5-4300U, Pentium® N4200, Celeron® J1900
- **System memory:**
 - 1 x 204-pin SO-DIMM DDR3L 1333 MHz up to 8 GB (UTC-315D/E)
 - 1 x 260-pin SO-DIMM DDR4 2133 MHz up to 16 GB (UTC-315F)
 - 1 x 204-pin SO-DIMM DDR3L 1866 MHz up to 8GB for (UTC-315G)
 - 1 x 260pin SO-DIMM DDR4 2400 MHZ up to 32GB (UTC-315H)
- **Serial ports:** 1 x RS-232 COM, 1 x RS-232 / 422 / 485
- **Universal serial bus (USB) port:**
 - Supports up to 5 x USB 2.0/1X USB 3.0 (UTC-315D)
 - Supports up to 2 x USB 2.0/4 x USB 3.0 (UTC-315E/F/G)
 - Supports up to 6 x USB 3.1 (UTC-315H)
- **Bus Expansion slot::**
 - Full-size MiniPCIe (UTC-315D/E/F)
 - Full-size MiniPCIe for mSATA (UTC-315D/E/F/G)
 - M.2 2230 for Wireless LAN card (UTC-315G)
 - M.2 2230 for Wireless LAN card (UTC-315G/H)
 - M.2 2242/M.2 2280 for NVMe storage (UTC-315H)
- **Watchdog timer:** Single chip Watchdog 255-level interval timer, setup by software
- **Power management:** Full ACPI (Advanced Configuration and Power Interface) 2.0 Supports S0, S1, S3,S4, S5

1.2.3 Audio Function

- **Audio:** High Definition Audio (HD), 2 W x 2 Speakers
- Optional - Audio output function

1.2.4 LAN Function

- **Chipset:**
 - LAN1 Intel WGI211AT, LAN2 Intel WGI211AT for UTC-315D/G
 - LAN1 Intel I218LM, LAN2 Intel WGI211AT for UTC-315E
 - LAN1 Intel I219LM, LAN2 Intel WGI211AT (UTC-315F/H)
- **Speed:** 1000 Mbps /Interface: 2 x RJ45
- **Wake-on-LAN:** Supports Wake-on-LAN function with ATX power control and supports LAN teaming (in fault tolerance)

1.2.5 Touch Screen (Optional)

Type	Analog Resistive 5-wires (Res. Flat Glass) / Projected Capacitive Touch Panel (Pcap. Flat Glass)
Light Transmission	80%
Controller	USB interface
Durability (touches in a lifetime)	36 million

1.2.6 Environment

- **Operating temperature:** 0 ~ 40° C (32 ~ 104° F)
- **Storage temperature:** -20 ~ 60° C
- **Relative humidity:** 10 ~ 95% @ 40° C (non-condensing)
- **Shock:** 10 G peak acceleration (11 ms duration)
- **Certification:**
 - EMC: CE, FCC, BSMI, VCCI.
 - Safety: UL, CB, CCC, BSMI
- **Vibration:** 5 ~ 500 Hz 0.5 G RMS Random vibration
- **VESA Support:** 75 x 75 mm (screw type- M4 x 8)

Caution! Use suitable mounting apparatus to avoid risk of injury.



- Supports landscape and portrait screen modes.



1.3 LCD Specifications

- **Display type:** 15.6" TFT LCD
- **Max. resolution:** 1366 x 768 (UTC-315D/E/F), 1920 x 1080 (UTC-315G/H)
- **Colors:** 262 K
- **Pixel Pitch (um):** 252 (H) x 252 (V)
- **View Angle:** 90°/60° (UTC-315D/E/F), 170°/170° (UTC-315G/H)
- **Luminance:** 220 cd/m²

1.4 Optional modules

- **Memory:**
 - 1 x 204-pin SO-DIMM DDR3L 1333 MHz up to 8 GB (UTC-315D/E)
 - 1 x 260-pin SO-DIMM DDR4 2133 MHz up to 16 GB (UTC-315F)
 - 1 x 204-pin SO-DIMM DDR3L 1866 MHz up to 8GB (UTC-315G)
 - 1 x 260pin SO-DIMM DDR4 2400 MHZ up to 32GB (UTC-315H)
- **HDD:** 2.5" SATA HDD
- **Operating System:**
 - WES 7P (32 bit) UTC-315D/F
 - WES 7E (32 bit) UTC-315D/F
 - Windows Pro Embedded 7 SP1 (64 bit) UTC-315D/F
 - WE8S (64 bit) UTC-315D/F
 - Windows Embedded 8.1 Industry Pro (64 bit)
 - Windows 10 IoT Enterprise (64 bit)
 - Linux (UTC-315D/E/F/G/H)
 - Android 6.0 (only UTC-315D)
 - Android 10.0 (only UTC-315G)
- **Touchscreen:** Analog Resistive 5-wires (Res. Flat Glass) / Projected Capacitive Touch Panel (Pcap. Flat Glass) / Glass Panel
- **Power cord:** 1702002600 (US) 1702002605 (Europe)

■ **Wireless LAN Module:**

Part No.	Description
1750008953-01(UTC-315D/E/F)	Metal antenna D.B 2.4+5G WLAN MHF1/113 BLK L350
EWM-W157H01E(UTC-315D/E/F)	802.11 a/b/g/n/ac,RTL8821AE, with BT4.0
1750008954-01(UTC-315G/H)	Metal antenna D.B 2.4+5G WLAN MHF4/113 BLK L350
EWM-W163M201E(UTC-315G/H)	802.11 a/b/g/n/ac,QCA6174A,2T2R,w/BT4.1,M.2

1.5 Dimensions

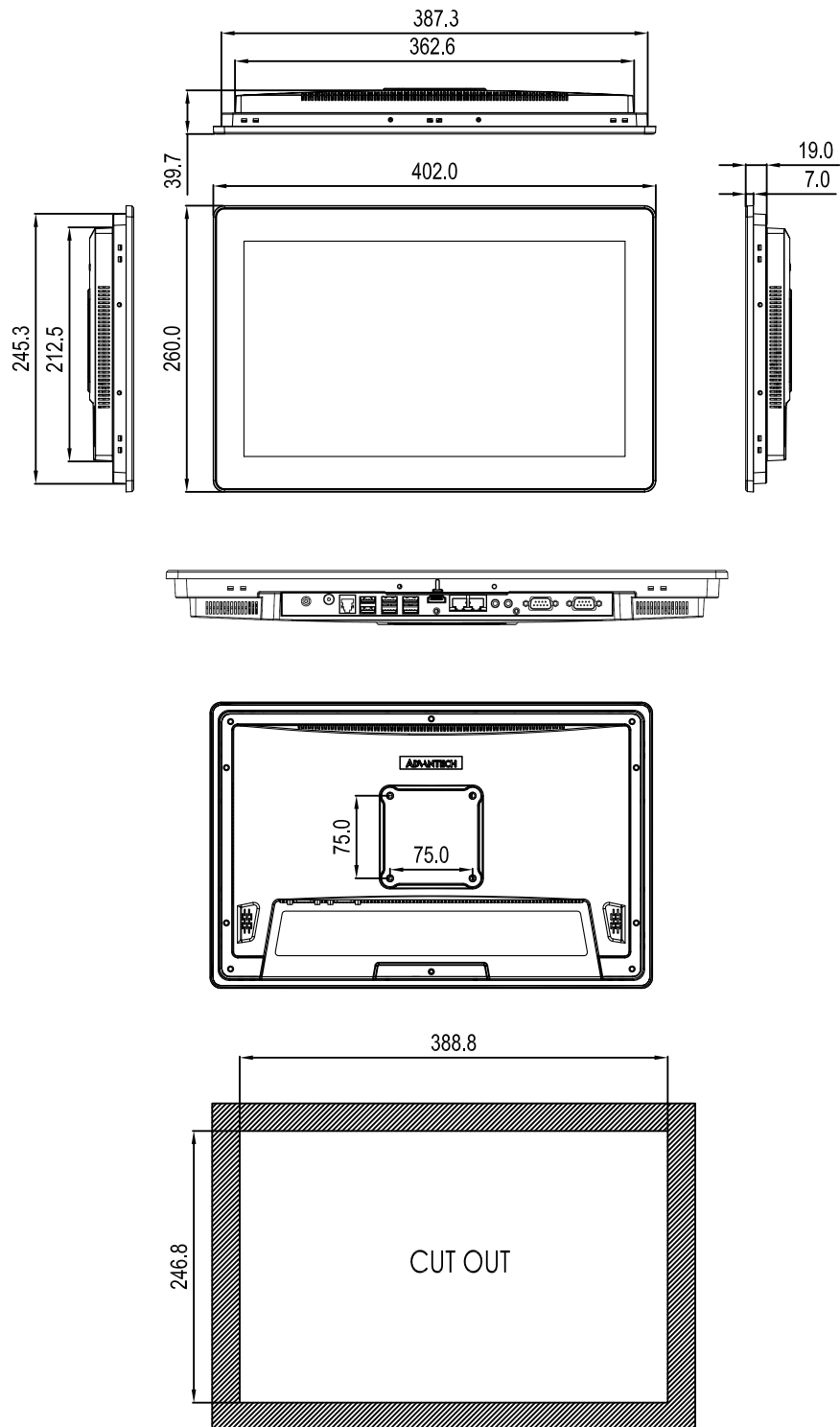

Figure 1.1 Dimensions of UTC-315

Chapter 2

System Setup

This chapter details system setup on the UTC-315.

Sections include:

- A Quick Tour of the UTC-315
- Installation procedures
- Running the BIOS Setup Program
- Installing System Software

2.1 A Quick Tour of the UTC-315

Before you start to set up the UTC-315, take a moment to become familiar with the locations and purposes of the controls, drives, connectors and ports, which are illustrated in the figures below. When you place the UTC-315 upright on the desktop, its front panel appears as shown in Figure 2.1.

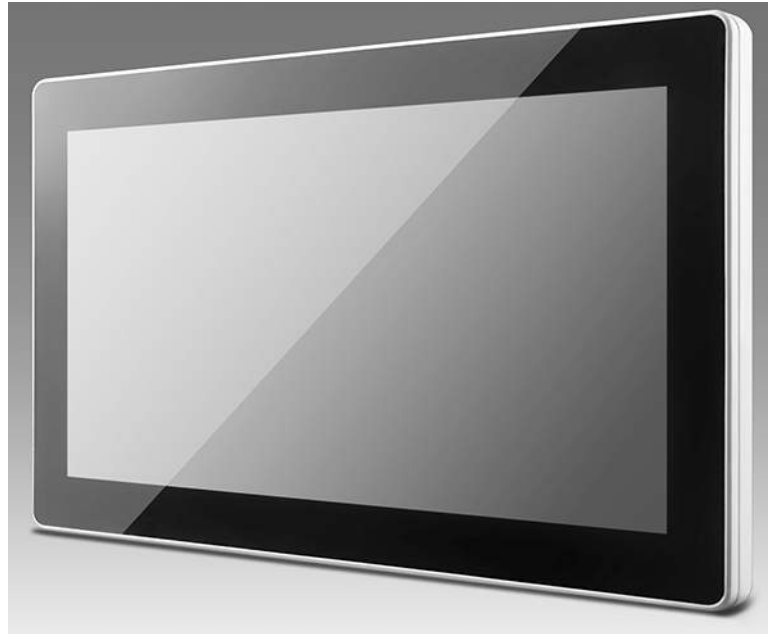

Figure 2.1 Front view of UTC-315

When you turn the UTC-315 around and look at its rear cover, you will find the I/O section as shown in Fig. 2.2. (The I/O section includes various I/O ports, including serial ports, Ethernet ports, USB ports, HDMI, and LINE-OUT / MIC-IN, RJ11, DC-IN, Power button.)



Figure 2.2 Rear view of UTC-315

UTC-315D/E/F/G I/O Port

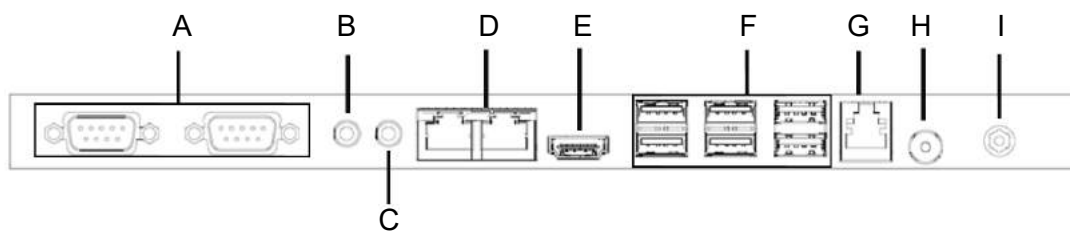

- | | |
|-------------------------------|---|
| A. COM Port | B. Line-out (Mic-in UTC-315G) |
| C. MIC-IN (Line-out UTC-315G) | D. Gigabit LAN x2 |
| E. HDMI | F. USB3.0 x 4/ USB 2.0 x 2 (UTC-315E/F/G) |
| G. RJ11 | USB3.0 x 1/ USB 2.0 x 5 (UTC-315D) |
| H. DC-IN | I. Power switch |

UTC-315H Port

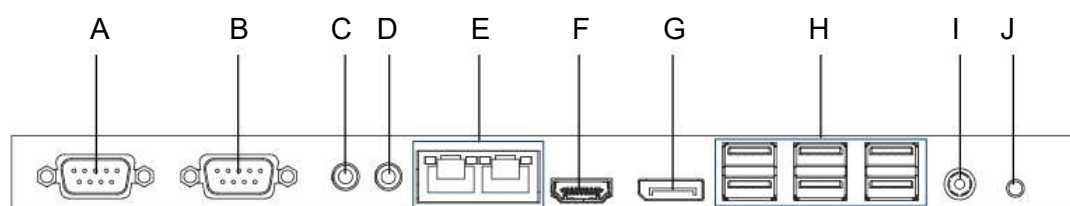

- | | |
|--------------------|-----------------|
| A. COM1 | B. COM2 |
| C. Mic in | D. Line-out |
| E. LAN ports x 2 | F. HDMI |
| G. DP | H. USB 3.1 x 6 |
| I. DC input 12-30V | J. Power button |

2.2 Installation Procedures

2.2.1 Connecting the power cord

The UTC-315 can be powered by a DC electrical outlet. Be sure to always handle the power cords by holding the plug ends only. Please follow the Figure 2.3 to connect the male plug of the power cord to the DC inlet of the UTC-315.

2.2.2 Connecting the keyboard or mouse

Before you start the computer, please connect keyboard port on the I/O section of the UTC-315.

2.2.3 Switching on the power

When you look at the rear side of the UTC-315, you will see the power switch as shown in Figure 2.3.



Figure 2.3 Connect the power cord to the DC inlet

2.3 Running the BIOS Setup Program

Your UTC-315 is likely to have been properly set up and configured by your dealer prior to delivery. You may still find it necessary to use the UTC-315's BIOS (Basic Input-Output System) setup program to change system configuration information, such as the current date and time or your type of hard drive. The setup program is stored in read-only memory (ROM). It can be accessed either when you turn on or reset the UTC-315, by pressing the "Del" key on your keyboard immediately after powering on the computer.

The settings you specify with the setup program are recorded in a special area of memory called CMOS RAM. This memory is backed up by a battery so that it will not be erased when you turn off or reset the system. Whenever you turn on the power, the system reads the settings stored in CMOS RAM and compares them to the equipment check conducted during the power on self-test (POST). If an error occurs, an error message will be displayed on screen, and you will be prompted to run the setup program.

COM2 RS232/RS422/RS485 Selection:

Enter Into BIOS setup → Advanced → Super IO Configuration.

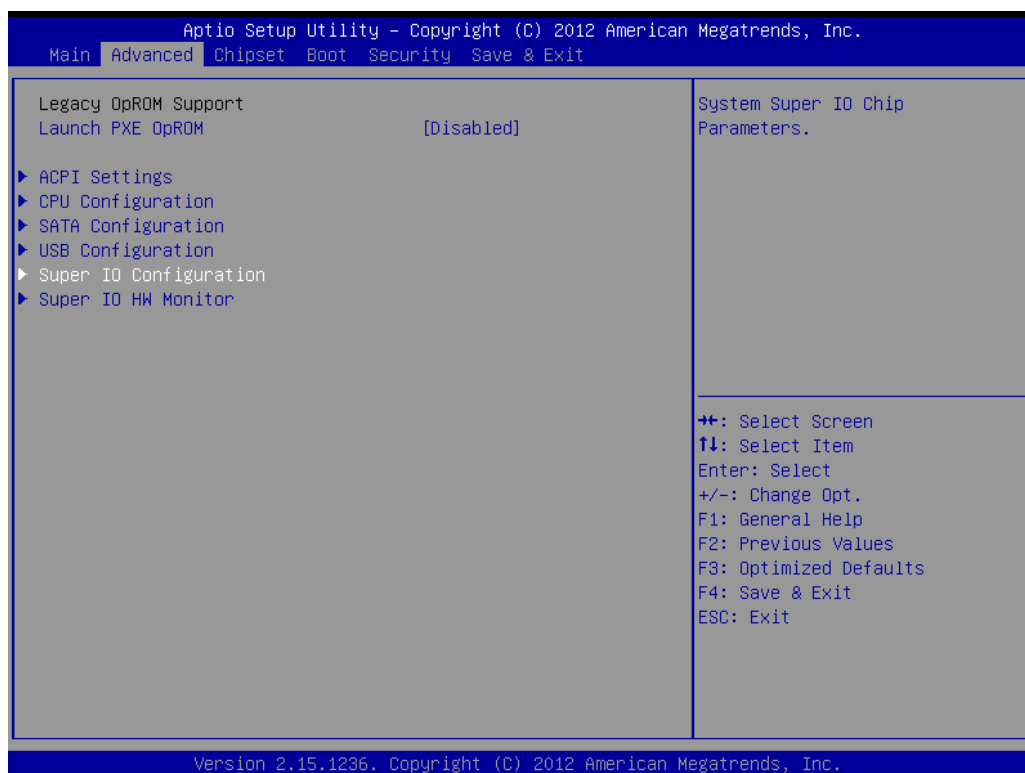

Select Serial Port 2 Configuration.

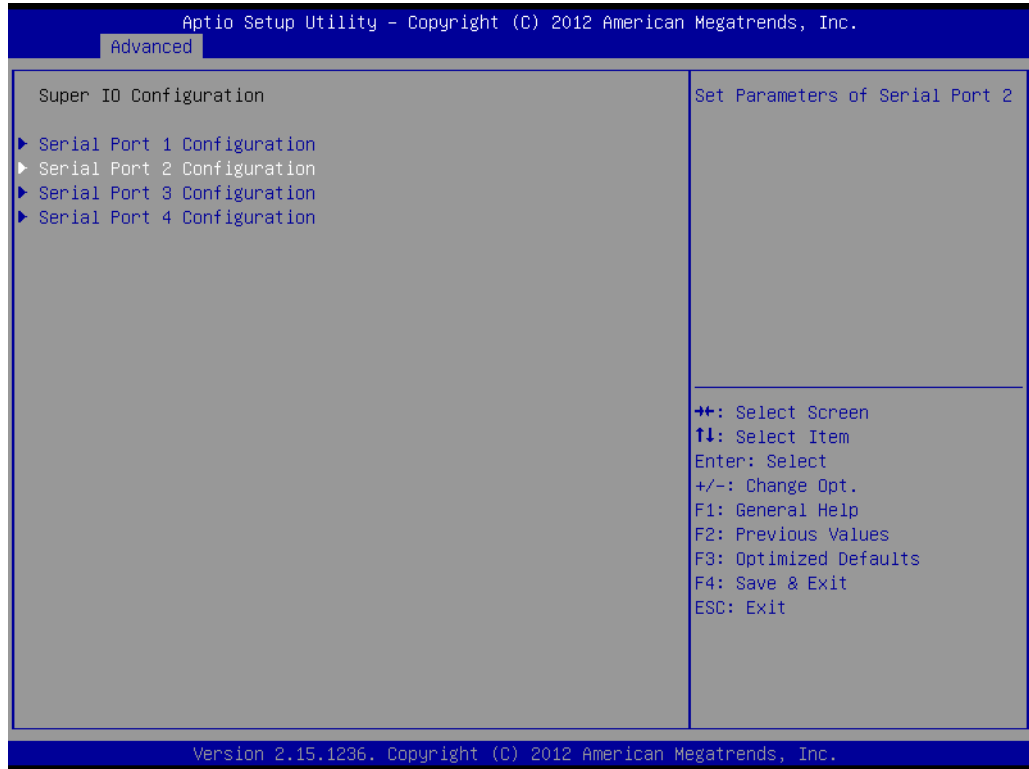

Change Serial Port 2 Mode [RS232/RS422/RS485].

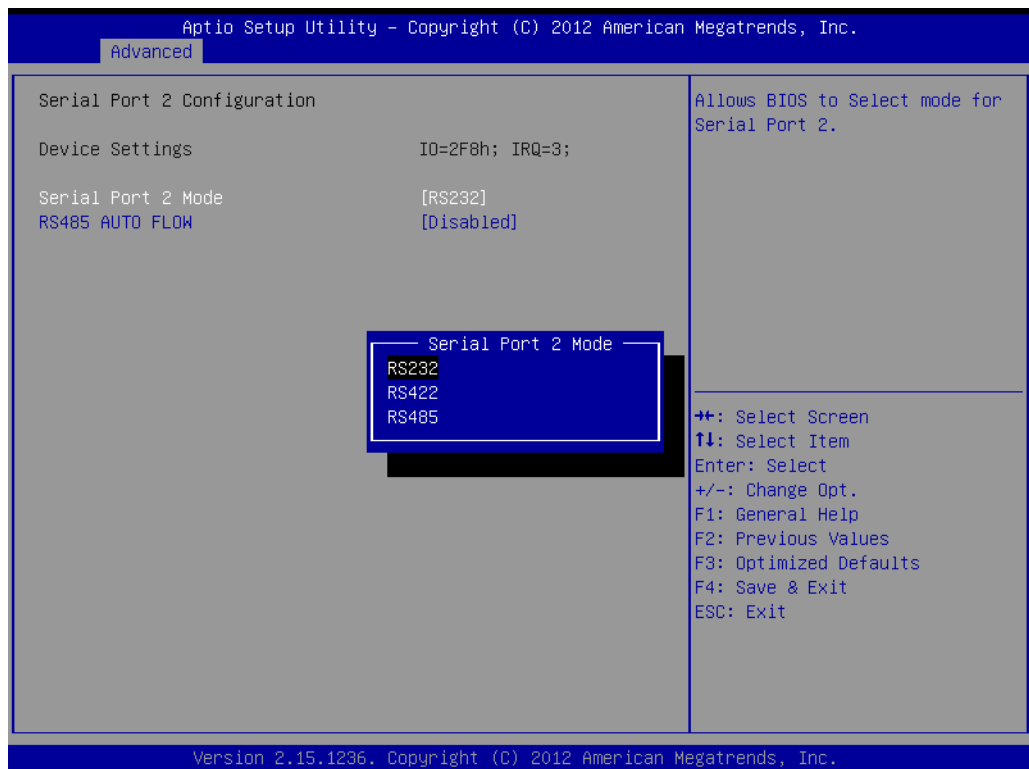

2.4 Installing System Software

Recent releases of operating systems from major vendors include setup programs which load automatically and guide you through hard disk preparation and operating system installation. The guidelines below will help you determine the steps necessary to install your operating system on the UTC-315 hard drive.

Note! *Some distributors and system integrators may have already pre-installed system software prior to shipment of your UTC-315.*



Installing software requires an installed HDD. Software can be loaded in the UTC-315 using any of four methods:

2.4.1 Method 1: Ethernet

You can use the Ethernet port to download software to the HDD.

2.4.2 Method 2: External USB CD-ROM

If required, insert your operating system's installation or setup diskette into the diskette drive until the release button pops out.

The BIOS of UTC-315 supports system boot-up directly from the CD-ROM drive. You may also insert your system installation CD-ROM into the CD-ROM drive.

Power on your UTC-315 or reset the system by pressing the “Ctrl+Alt+Del” keys simultaneously. The UTC-315 will automatically load the operating system from the diskette or CD-ROM.

If you are presented with the opening screen of a setup or installation program, follow the instructions on screen. The setup program will guide you through preparation of your hard drive, and installation of the operating system. If you are presented with an operating system command prompt, such as A:\>, then you must partition and format your hard drive, and manually copy the operating system files to it. Refer to your operating system user manual for instructions on partitioning and formatting a hard drive.

2.5 Installing the Drivers

After installing your system software, you will be able to set up the Ethernet, chipset, graphics, audio, USB 3.0, and touchscreen functions. you can download drivers from the Advantech website.

Note! *The drivers and utilities used for the UTC-315 are subject to change without notice.*



If in doubt, check Advantech's website or contact our application engineers for the latest information regarding drivers and utilities.

Chapter 3

Hardware Installation and Upgrades

This chapter details installing the UTC-315 hardware.

Sections include:

- Overview of Hardware Installation and Upgrading
- Installing the 2.5" Hard Disk Drive (HDD)
- Installing the mSATA
- Installing the WLAN

3.1 Introduction

The UTC-315 consists of a PC-based computer that is housed in a plastic enclosure. You can install a HDD, DRAM, and MiniSATA card by removing the rear cover. Any maintenance or hardware upgrades can be easily completed after removing the rear cover.

Warning! Do not remove the rear cover until you have verified that no power is flowing within the UTC-315. Power must be switched off and the power cord must be unplugged. Every time you service the UTC-315, you should be aware of this.



3.2 Installing the 2.5" Hard Disk Drive (HDD)

You can attach one Serial Advanced Technology Attachment (SATA) hard disk drive to the UTC-315's internal controller. The SATA controller supports faster data transfer and allows the SATA hard drive to exceed 150 MB. The following are instructions for installation:

1. Detach and remove the rear cover.
2. Place the HDD in the metal bracket, and tighten the screws (see Figure 3.1).
3. The HDD cable (SATA 7P+1*5P-2.5/SATA(15+7)P) is next to the metal brace. Connect the HDD cable to the motherboard (SATA1/SATA POWER). Plug the other end of the cable into the SATA hard drive.
4. Put the rear cover on and tighten the screws.

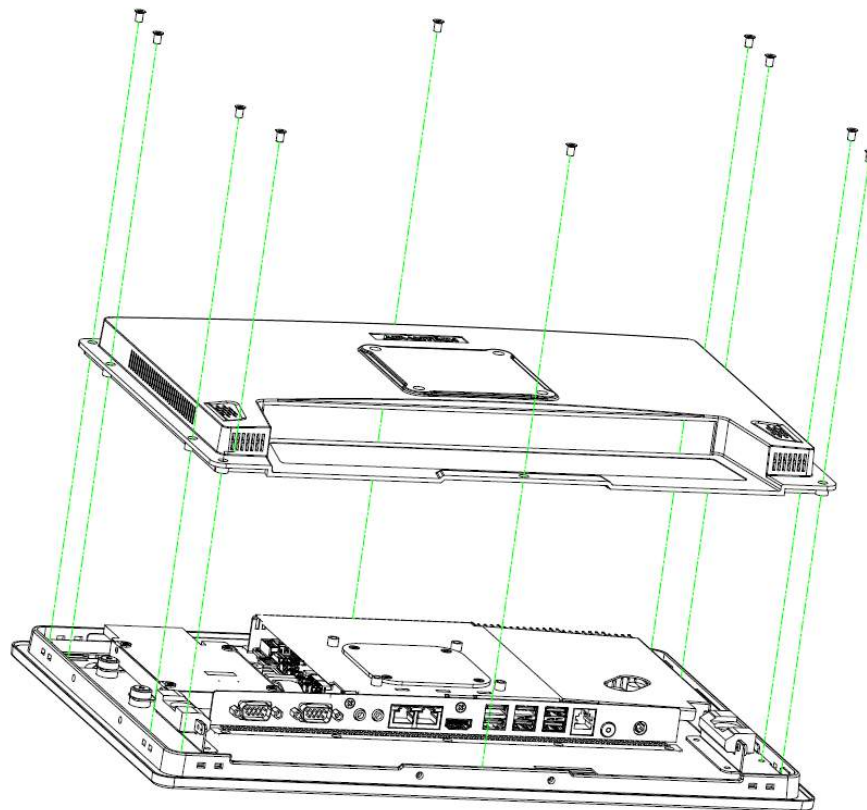

Figure 3.1 Installing primary 2.5" HDD

3.3 Installing the mSATA/m.2 Card

1. Remove the 10 screws on the rear cover.
2. Remove the 6 screws on the reinforced board.
3. Insert an mSATA/m.2 card into the slot.
4. Replace and tighten the screws on the reinforced board.
5. Replace the rear cover and secure in place with screws.

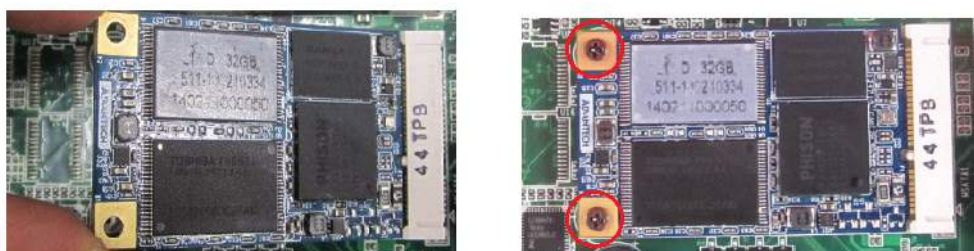
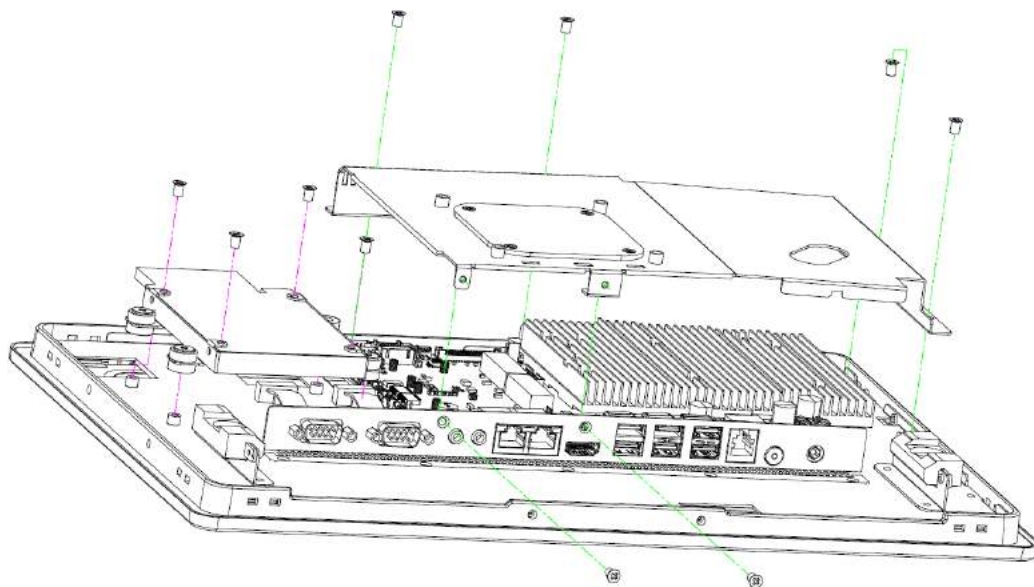
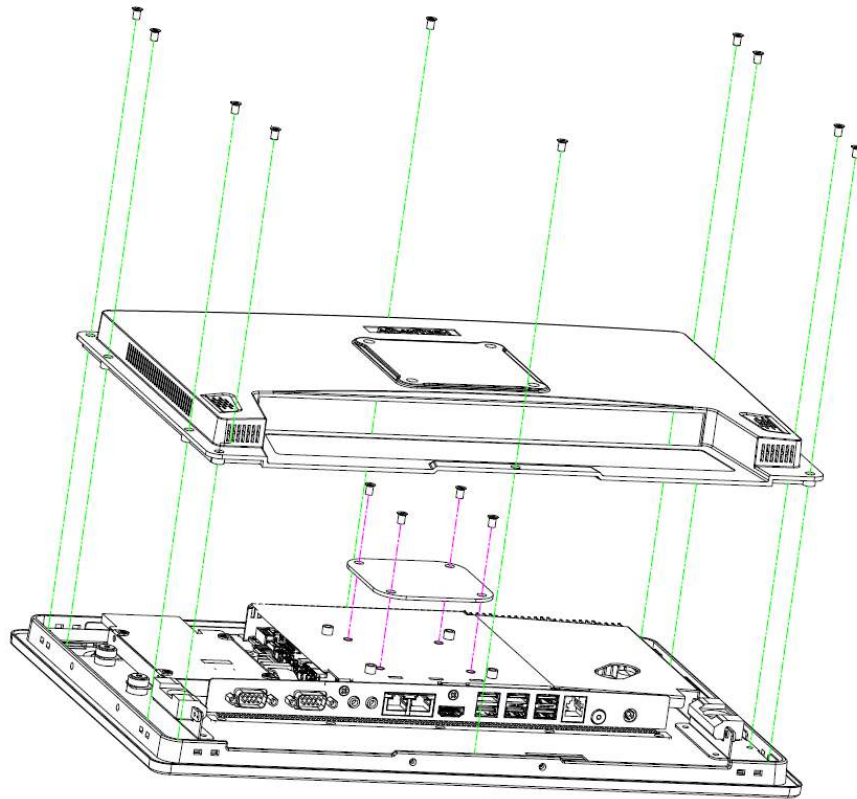

Figure 3.2 Installing the mSATA/m.2 Card

3.4 Installing the WLAN

Reserve two locations for the external Antenna. One is at the IO port, the other is at the rear cover. Customers can choose based on their requirement.

1. Remove 10 x screws from the back cover.



2. Remove 6 screws on the reinforced board.
3. Coaxial cable (Advantech P/N: 1750008953-01 (for UTC-315D/E/F), 1750008954-01 (for UTC-315G))

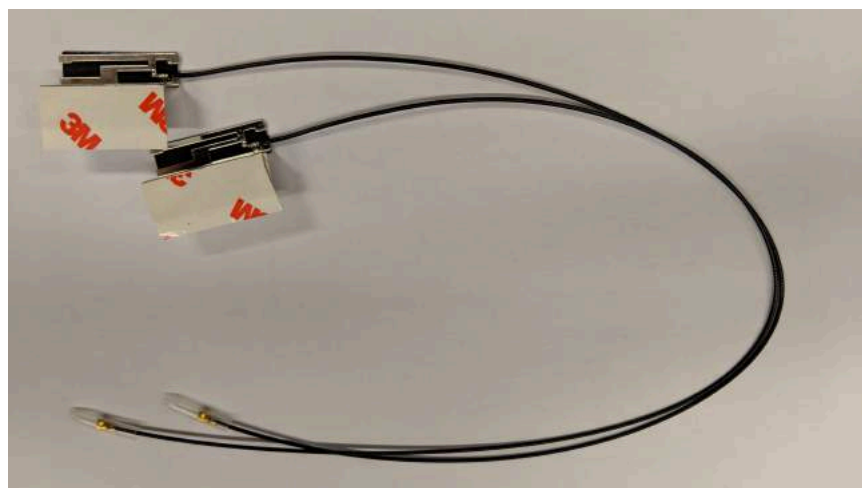

4. Connect the coaxial cable to "ANT1" on the WLAN card.



5. Install the WLAN card on M/B bottom side.

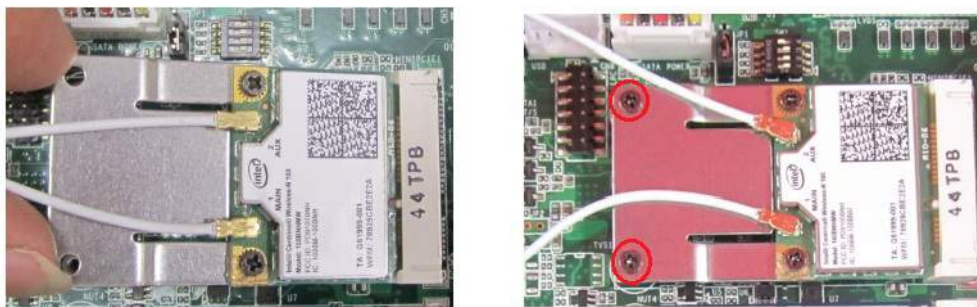

6. Cable routing of the wireless antenna is shown below.

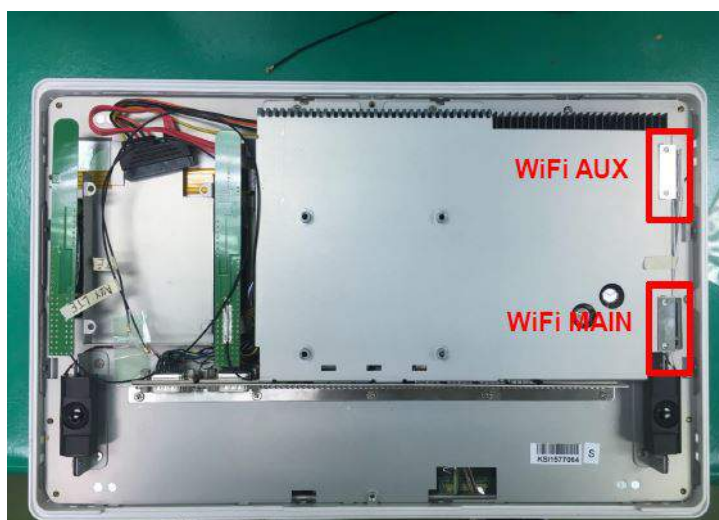

Chapter 4

Jumper and Connector Settings

This chapter details instructions for setting jumpers and connecting peripherals, switches, and indicators.

- Jumpers and Connectors
- CMOS Clear for External RTC (JP3)
- COM Port Interface
- Watchdog Timer Configuration

4.1 Jumpers and Connectors

4.1.1 Setting Jumpers

Users can configure the UTC-315 to match their application needs by setting jumpers. A jumper is the simplest type of electrical switch and consists of two metal pins and a small metal clip (typically protected by a plastic cover) that slides over the pins to connect them. To close a jumper, connect the pins with the clip. To open a jumper, simply remove the clip. Some jumpers have three pins, labeled 1, 2, and 3. In such cases, connect either Pins 1 and 2, or Pins 2 and 3.

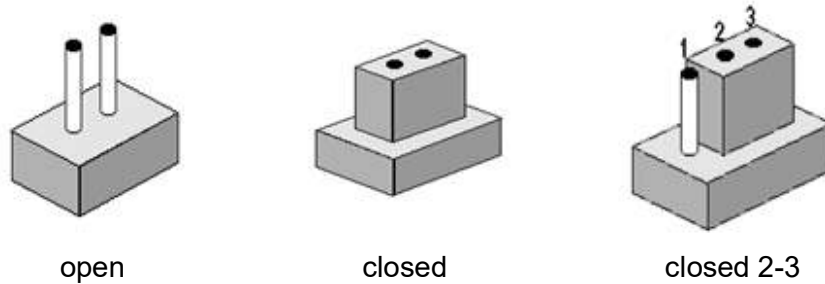

The jumper settings are schematically depicted below.

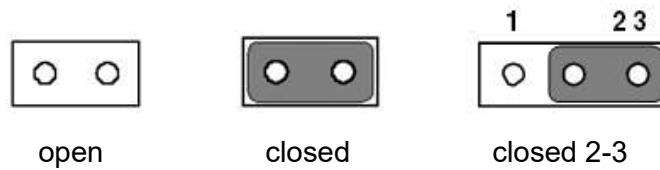

A pair of needle-nose pliers may be helpful when working with jumpers. If you have any concerns regarding the optimum hardware configuration for your application, contact your local distributor or sales representative before making any changes.

4.1.2 Jumpers and Connectors

Table 4.1: Jumper and Connector Functions

CN1(DE),CN2(FGH)	Back_Light
CN3(D),CN38(H),CN39(H)	Internal USB
CN4(DEFG),LVDS1(H)	LVDS
CN5(D),CN8(EFG), CN9(H)	Edp
CN11(DF),CN10(G)	VGA
SATA,SATA1(H)	SATA
CN7(D),CN3(EFG),CN25(H)	SATA POWER
CN23(H)	SATA LED
CN8(D),CN5(G)	Internal USB
CN9(D),CN6(EG,)CN26(F),CN41(H)	Touch
CN13(D),DIMM(EFG),CN1(H)	DR3L/4 SODIMM
MINIPCIE1(DEF)	MINIPCIE
MSATA1(DEFG)	MSATA
CN14(D),CN10(F),CN7(GH)	COM4
CN15(D),CN12(F),CN9(G),CN96(H)	COM3
CN11(E)	CSAFE
CN16(D),CN13(E),CN14(F),CN11(G),CN44(H)	COM2
CN18(D),CN14(E),CN15(F),CN13(GH)	COM1
CN21(D),CN16(EF),CN23(G),CN45(H)	Power on switch
CN22(D),CN15(E),CN16(FG),CN168(H)	Speaker
M.2_1(G),CN16(H)	M.2(2230)
M2M1(H)	M.2(2280)
CN23(D),CN17(EFG),CN11(H)	LAN1/LAN2
CN24(D),CN19(EF),CN21(G),CN170(H)	External USB
CN25(D),CN20(EF),CN22(G),CN169(H)	External USB
CN26(D),CN18(EF),CN20(G),CN43(H)	External USB
CN27(D),CN21(E),CN22(F),CN25(G),CN66(H)	Line-out
CN28(D),CN22(E),CN21(F),CN24(GH)	MIC-IN
CN30(D),CN24(EF),CN27(G),CN15(H)	HDMI
CN42(H)	DP
CN31(DG),CN25(EF),DCIN1(H)	DC-IN
CN29(D),CN23(EF),CN26(G)	RJ11
BUTTON,SW5(H),CN45(H)	Power button

4.1.3 Locating Jumpers and Connectors

PCM-U301(UTC-315D)

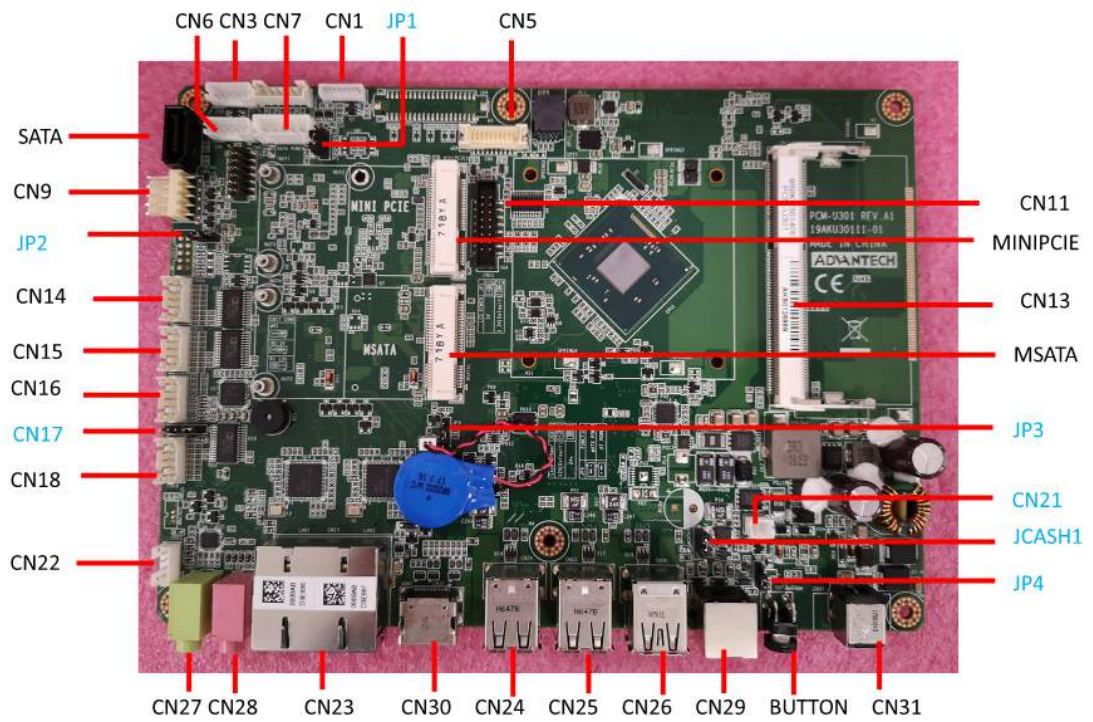

PCM-U302(UTC-315E)

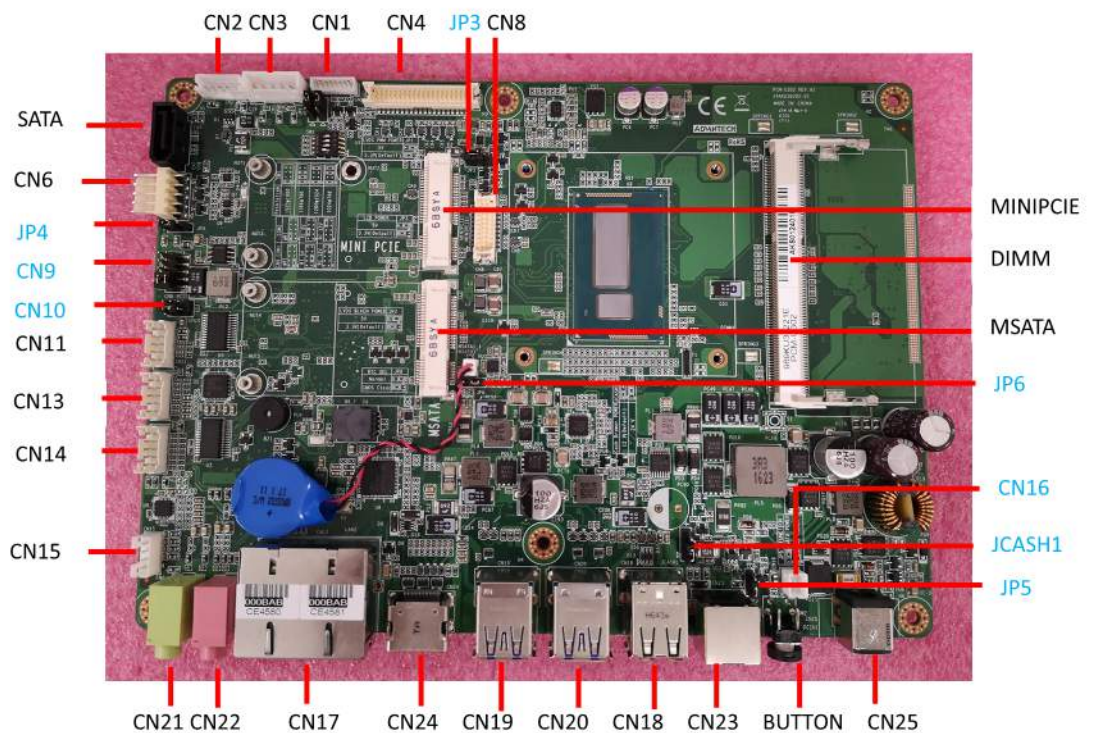

PCM-U303 (UTC-315F)

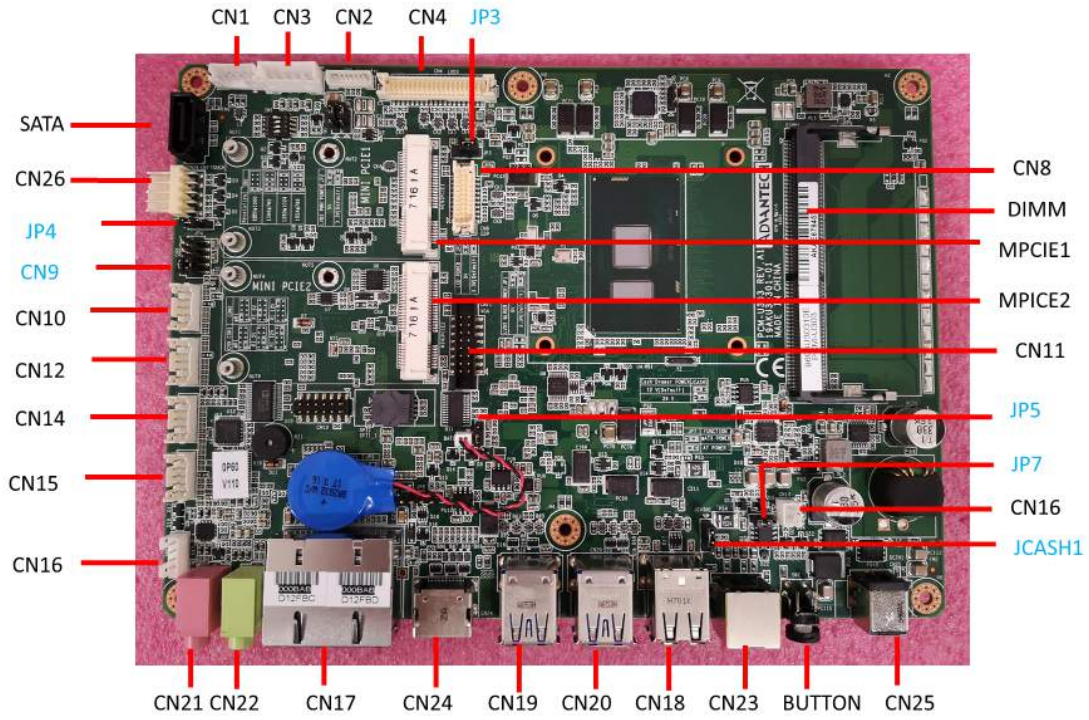

PCM-U304 (UTC-315G)

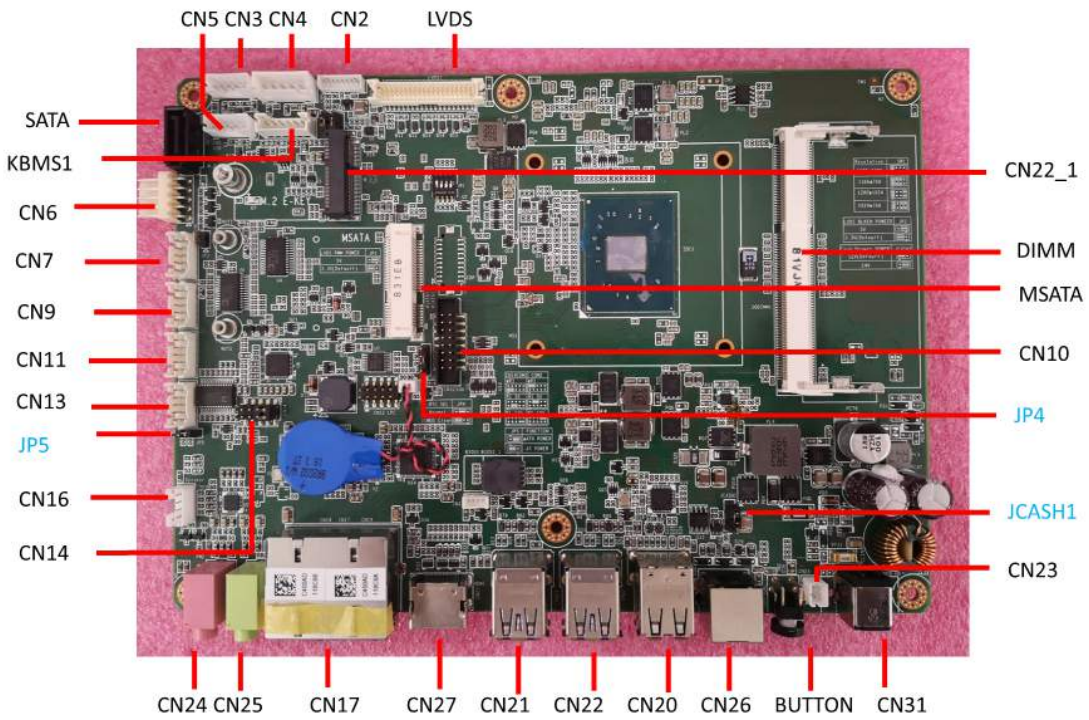

PCM-U305 (UTC-315H)

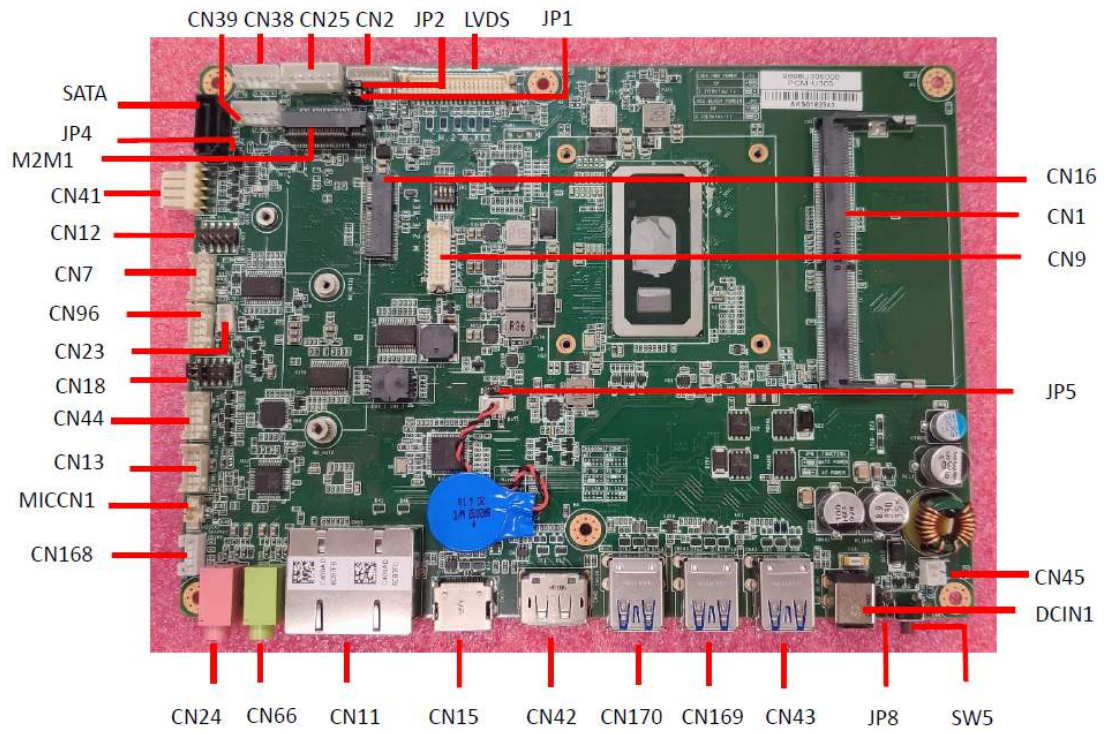

4.2 Jumpers

4.2.1 Jumper List

Table 4.2: Jumper List	
JP1(DH),JP3(EF)	LCD POWER
JP3(D),JP6(E),JP5(FH),JP4(G)	Clear CMOS
JP4(H)	TS POWER
JP4(D),JP5(EG),JP7(F),JP8(H)	AT/ATX POWER SEL
CN17(D),CN9(EF),CN14(G),CN18(H)	COM1,COM2 RING
JCASH1	Cash drawer power
CN10(E)	CSAFE POWER
JP1(H)	PWM Power
JP2(H)	BKLT_EN Power

4.2.2 Jumper Settings

Table 4.3: P1(D),JP3(EF):LCD POWER	
Part Number	1653003100
Footprint	HD_3x1P_100_D
Description	PIN HEADER 3x1P 2.54mm 180D(M) DIP 205-1x3GS
Setting	Function
(1-2)	5V
(2-3)*	3.3V

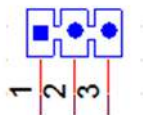

Table 4.4: JP1(H):PWM POWER	
Part Number	1653003101
Footprint	HD_3x1P_79_D
Description	PIN HEADER 3x1P 2.0mm 180D(M) DIP 2000-13 WS
Setting	Function
(1-2)	5V
(2-3)*	3.3V

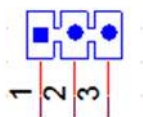

Table 4.5: JP2(H):BKLT Enable POWER

Part Number	1653003101
Footprint	HD_3x1P_79_D
Description	PIN HEADER 3x1P 2.0mm 180D(M) DIP 2000-13 WS
Setting	Function
(1-2)	5V
(2-3)*	3.3V

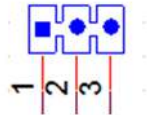

Table 4.6: JP3(D),JP6(E),JP5(F),JP4(G):Clear CMOS

Part Number	1653004101
Footprint	HD_4x1P_79_D
Description	PIN HEADER 4x1P 2.0mm 180D(M) DIP 21N12050
Setting	Function
(2-3)*	Normal
(3-4)	Clear CMOS

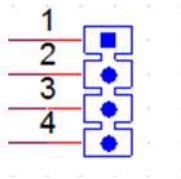

Table 4.7: JP5(H):Clear CMOS

Part Number	1653003101
Footprint	HD_3x1P_79_D
Description	PIN HEADER 3x1P 2.0mm 180D(M) DIP 2000-13 WS
Setting	Function
(1-2)*	Normal
(2-3)	CMOS Clear

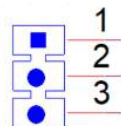
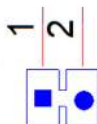
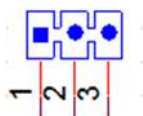

Table 4.8: JP4(H):TS POWER

Part Number	1653002101-02
Footprint	HD_2x1P_79_D
Description	PIN HEADER 2x1P 2.0mm 180D(M) DIP 21N12050
Setting	Function
(1-2)	3.3V

**Table 4.9: JP4(D),JP5(EG),JP7(F),JP8(H):AT/ATX POWER SEL**

Part Number	1653003101
Footprint	HD_3x1P_79_D
Description	PIN HEADER 3*1P 180D(M) 2.0mm DIP 2000-13 WS
Setting	Function
(1-2)	AT
(2-3)*	ATX

**Table 4.10: CN17(D):COM1 Ring**

Part Number	1653005101
Footprint	HD_5x1P_79_D
Description	PIN HEADER 5x1P 2.0mm 180D(M) DIP 1140-000-05SN
Setting	Function
(1-2)	RING
(3-4)*	COM1 RI output +5V
(4-5)*	COM1 RI output +12V

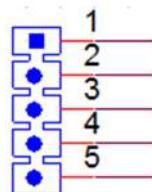
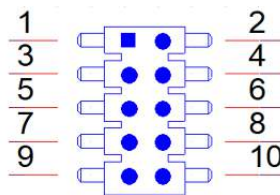
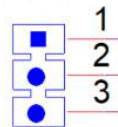

Table 4.11: CN9(EF),CN14(G),CN18(H):COM1,COM2 Ring

Part Number	1653005261
Footprint	HD_5x2P_79
Description	PIN HEADER 5x2P 2.0mm 180D(M) SMD 21N22050
Setting	Function
(1-3)	COM1 RING
(2-4)	COM2 RING
(3-5)*	COM1 RI output +5V
(4-6)*	COM2 RI output +5V
(7-9)*	COM1 RI output +12V
(8-10)*	COM2 RI output +12V

**Table 4.12: JCASH1: CASH DRAWER POWER SEL**

Part Number	1653003100
Footprint	HD_3x1P_100_D
Description	PIN HEADER 3x1P 2.54mm 180D(M) DIP 1130-000-03S
Setting	Function
(1-2)	12V
(2-3)*	24V

**Table 4.13: CN10: CSAFE Power**

Part Number	1653003201
Footprint	HD_3x2P_79_D
Description	PIN HEADER 3x2P 2.0mm 180D(M) DIP 21N22050
Setting	Function
(1-3) *	CSAFE output +5V
(3-4)	CSAFE output +9V
(3-5)	CSAFE output +12V

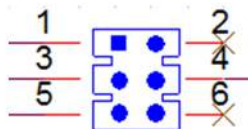

Appendix **A**

I/O Pin Assignments

A.1 Pin Assignments

Table A.1: CN1(DE),CN2(FGH):Back Light

Part Number	1655004512-01
Footprint	WF_8P_49_BOX_D
Description	WAFER BOX 8P 1.25mm 180D(M) DIP A1251WV0-8P
Pin	Pin name
1	+12V_INVERTER
2	+12V_INVERTER
3	GND
4	GND
5	BKLT_EN
6	BRIGHT1
7	+12V_INVERTER
8	GND

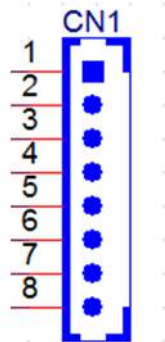

Table A.2: CN3(D):Internal USB

Part Number	1655000453
Footprint	WHL5V-2M-24W1140
Description	WAFER BOX 2.0mm 5P 180D(M) DIP WO/Pb JIH VEI
Pin	Pin name
1	+5V
2	D-
3	D+
4	GND
5	GND

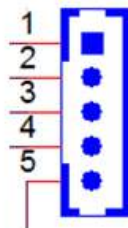
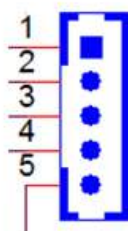

Table A.3: CN38(H),CN39(H):Internal USB

Part Number	1655305020
Footprint	WHL5V-2M
Description	WAFER BOX 2.0mm 5P 180D(M) DIP A2001WV2-5P
Pin	Pin name
1	+5V
2	D-
3	D+
4	GND
5	GND

**Table A.4: CN4(DEFG):LVDS**

Part Number	1653920200
Footprint	SPH20X2
Description	B/B Conn. 40P 1.25mm 90D SMD DF13-40DP-1.25V(91)
Pin	Pin name
1	+3.3V or +5V
2	+3.3V or +5V
3	GND
4	GND
5	+3.3V or +5V
6	+3.3V or +5V
7	LVDS0_D0-
8	LVDS1_D0-
9	LVDS0_D0+
10	LVDS1_D0+
11	GND
12	GND-
13	LVDS0_D1-
14	LVDS1_D1-
15	LVDS0_D1+
16	LVDS1_D1+
17	GND
18	GND
19	LVDS0_D2-
20	LVDS1_D2-
21	LVDS0_D2+
22	LVDS1_D2+-

Table A.4: CN4(DEFG):LVDS

23	GND
24	GND
25	LVDS0_CLK-
26	LVDS1_CLK-
27	LVDS0_CLK+
28	LVDS1_CLK+
29	GND
30	GND
31	LVDS0_DDC_SC
32	LVDS0_DDC_SD
33	GND
34	GND
35	LVDS0_D3-
36	LVDS1_D3-
37	LVDS0_D3+
38	LVDS1_D3+
39	+3.3V or +5V
40	+3.3V or +5V



Table A.5: LVDS1(H):LVDS	
Part Number	1653006918-01
Footprint	SPH20X2
Description	(DEL20)Wafer 2x20P/1.25mm/(M)/NY9T/VA/GFL/S/WH
Pin	Pin name
1	+3.3V
2	+3.3V
3	GND
4	GND
5	GND
6	GND
7	LVDS0_D0-
8	LVDS1_D0-
9	LVDS0_D0+
10	LVDS1_D0+
11	GND
12	GND-
13	LVDS0_D1-
14	LVDS1_D1-
15	LVDS0_D1+
16	LVDS1_D1+
17	GND
18	GND
19	LVDS0_D2-
20	LVDS1_D2-
21	LVDS0_D2+
22	LVDS1_D2+-
23	GND
24	GND
25	LVDS0_CLK-
26	LVDS1_CLK-
27	LVDS0_CLK+
28	LVDS1_CLK+
29	GND
30	GND
31	LVDS0_D3-
32	LVDS1_D3-
33	LVDS0_D3+
34	LVDS1_D3+
35	UD
36	RL
37	+5V
38	+5V
39	GND
40	GND
43	GND
44	GND

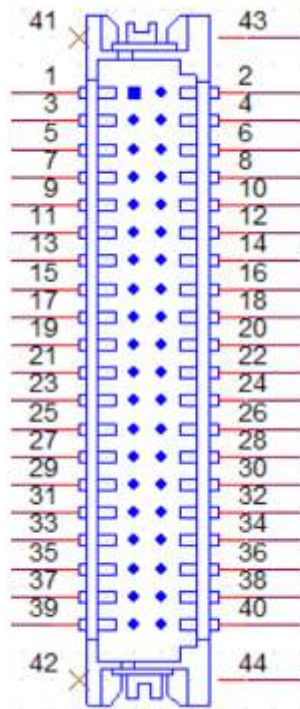

Table A.6: CN5(D),CN3(EF),CN9(H):eDP	
Part Number	1653006914-01
Footprint	WB10x2P-S1.25
Description	WTB 2x10P 1.25mm 180D(M) SMD W/P DF13E-20DP-1.25
Pin	Pin name
1	GND
2	GND
3	TXN0
4	TXN3
5	TXP0
6	TXP3
7	GND
8	NC
9	TXN1
10	GND
11	TXP1
12	AUX-
13	GND
14	AUX+
15	TXN2
16	GND
17	TXP2
18	HPD
19	LCD_POWER
20	LCD_POWER

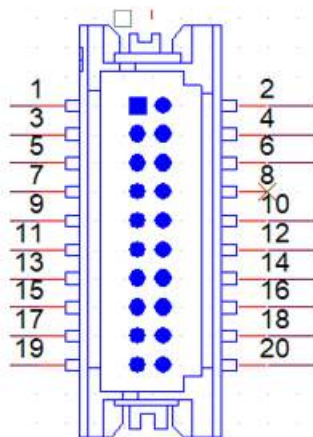

Table A.7: CN3(G) eDP

Part Number	1653006914-01
Footprint	WB10x2P-S1.25
Description	WTB 2x10P 1.25mm 180D(M) SMD W/P DF13E-20DP-1.25
Pin	Pin name
1	+5V_LCD
2	+5V_LCD
3	TXN0
4	GND
5	TXP0
6	TXN3
7	GND
8	TXP3
9	TXN1
10	GND
11	TXP1
12	AUX-
13	GND
14	AUX+
15	TXN2
16	GND
17	TXP2
18	HPD
19	+V3.3_LCD
20	+V3.3_LCD

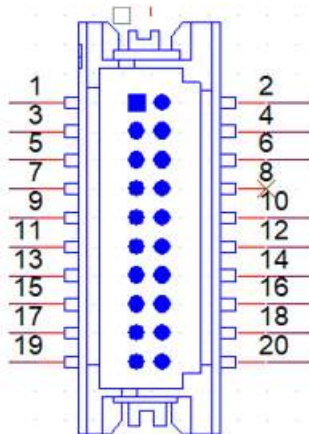
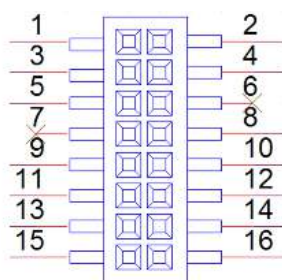

Table A.8: CN11(DF),CN10(G) VGA

Part Number	1653208260
Footprint	HD_8x2P_79_BOX
Description	BOX HEADER 8x2P 2.00mm 180D(M) SMD 23N6850
Pin	Pin name
1	VGA_R
2	+5V
3	VGA_G
4	GND
5	VGA_B
6	NC
7	NC
8	VGA_DDAT
9	GND
10	VGA_HS
11	GND
12	VGA_VS
13	GND
14	VGA_DCLK
15	GND
16	GND

**Table A.9: SATA(DEFG):SATA**

Part Number	1654004659
Footprint	WF_5P_98_BOX_D
Description	WAFER BOX 5P 2.5mm 180D(M) DIP 2503-WS-5
Pin	Pin name
1	GND
2	TX+
3	TX-
4	GND
5	RX+
6	RX-
7	GND

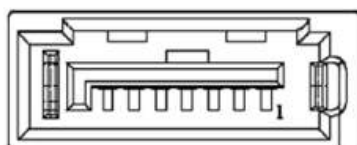

Table A.10: SATA1(H):SATA

Part Number	1654013471-01
Footprint	sata_7p_watm-07dbn4a3b8uw_d
Description	SATA 7P/1.27mm/(F)/NY46/VA/G15u/D/BK/H8.45mm
Pin	Pin name
1	GND
2	TX+
3	TX-
4	GND
5	RX-
6	RX+
7	GND

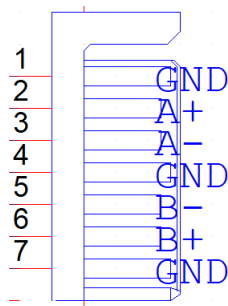

Table A.11: CN7(D),CN3(EFG),CN25(H):SATA POWER

Part Number	1659254005
Footprint	SATA_7P_WATM-07DBN4A3B8UW_D
Description	Serial ATA 7P 1.27mm 180D(M) DIP WATM-07DBN4A3B8
Pin	Pin name
1	+3.3V
2	GND
3	+5V
4	GND
5	+12V

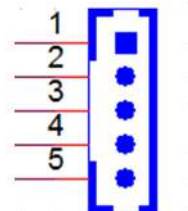
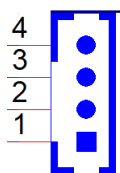

Table A.12: CN23(H):SATA LED

Part Number	1655000170
Footprint	WF_4P_49_BOX_R1_D
Description	WAFER 1.25mm 4P 180D DIP A1251WV0-4P
Pin	Pin name
1	+5VSB
2	+5V
3	SATA0_LED
4	GND

**Table A.13: CN8(D),CN5(G):Internal USB**

Part Number	1655000453
Footprint	WHL5V-2M-24W1140
Description	WAFER BOX 2.0mm 5P 180D(M) DIP WO/Pb JIH VEI
Pin	Pin name
1	+5V
2	D-
3	D+
4	GND
5	GND

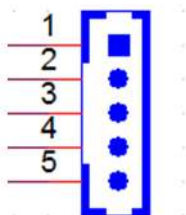
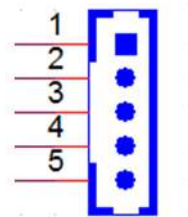

Table A.14: CN9(D),CN6(EG),CN26(F),CN41(H):Touch

Part Number	1655005110
Footprint	WF_5P_100_RA_D
Description	WAFER 5P 2.54mm 90D(M) DIP 2542-WR-5
Pin	Pin name
1	Y+
2	Y-
3	SENSE
4	X+
5	X-

**Table A.15: CN13(D),DIMM(EG):DDR3L SODIMM**

Part Number	1651002087-11
Footprint	DDR3_204P_AS0A626-N2S6-7H
Description	DDR3 SODIMM H=5.2mm STD 204P SMD AS0A626-H2S6-7H
Pin	Pin name

Table A.16: DIMM(F),CN1(H):DDR4 SODIMM

Part Number	1651002829-01
Footprint	SODIMMDDR4_260P_AS0A826-H2SB
Description	DDR4 SODIMM H=5.2mm 260P SMD AS0A826-H2SB-7H STD
Pin	Pin name

Table A.17: MINIPCIE1(DEF):MINIPCIE	
Part Number	1654002538
Footprint	FOX_AS0B226-S68K7F
Description	MINI PCI E 52P 6.8mm 90D SMD AS0B226-S68Q-7H
Pin	Pin name
1	MPCIE1_WAKE#
2	+3.3VSB
3	NC
4	GND
5	NC
6	NC
7	MPCIE_CLKREQ#
8	NC
9	GND
10	NC
11	CLK_MINI_PCIE-
12	NC
13	CLK_MINI_PCI+
14	NC
15	GND
16	NC
17	NC
18	GND
19	NC
20	MPCIE1_DISABLE#
21	GND
22	PLTRST#
23	PCIE_RX-
24	+3.3VSB
25	PCIE_RX+
26	GND
27	GND
28	+1.5V
29	GND
30	SMB_CLK_MPCIE1
31	PCIE_TX-
32	SMB_DAT_MPCIE1
33	PCIE_TX+
34	GND
35	GND
36	USB_D-
37	GND
38	USB_D+
39	+3.3VSB
40	GND
41	+3.3VSB
42	NC

Table A.17: MINIPCIE1(DEF):MINIPCIE

43	NC
44	NC
45	NC
45	NC
47	NC
48	NC
49	NC
50	GND
51	NC
52	+3.3VSB

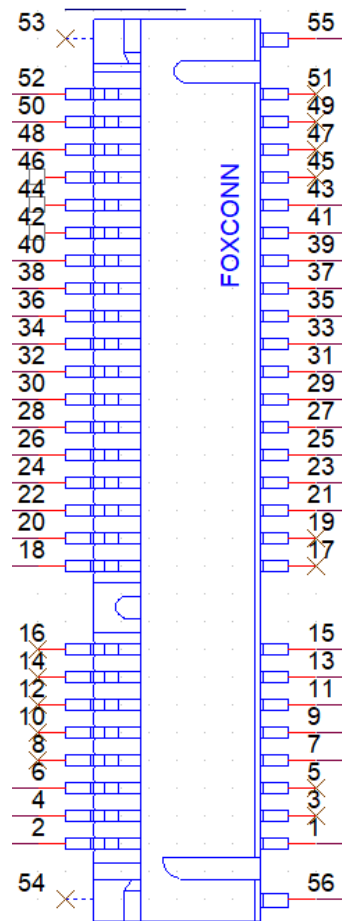

Table A.18: MSATA1(DEFG):MSATA

Part Number	1654002538
Footprint	FOX_AS0B226-S68K7F
Description	MINI PCI E 52P 6.8mm 90D SMD AS0B226-S68Q-7H
Pin	Pin name
1	NC
2	+3.3V
3	NC
4	NC
5	NC
6	NC
7	NC
8	NC
9	GND
10	NC
11	NC
12	NC
13	NC
14	NC
15	GND
16	NC
17	NC
18	GND
19	NC
20	NC
21	GND
22	NC
23	SATA1_RX+
24	+3.3V
25	SATA1_RX-
26	GND
27	GND
28	NC
29	GND
30	NC
31	SATA1_TX-
32	NC
33	SATA1_TX+
34	GND
35	GND
36	NC
37	GND
38	NC
39	+3.3V
40	GND
41	+3.3V
42	NC

Table A.18: MSATA1(DEFG):MSATA

43	NC
44	NC
45	NC
45	NC
47	NC
48	NC
49	NC
50	GND
51	+3.3V
52	+3.3V

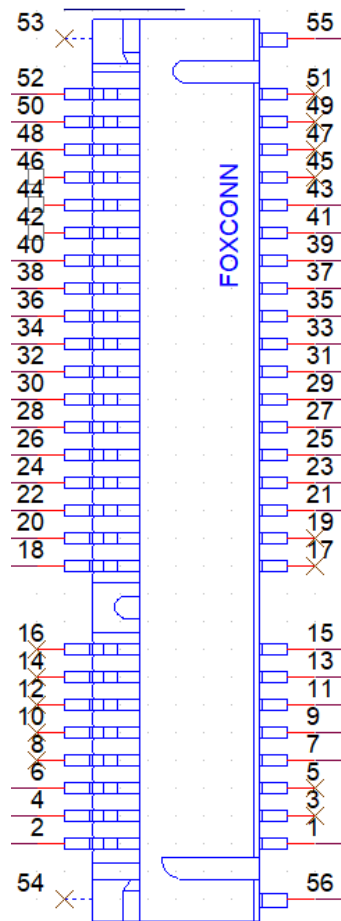
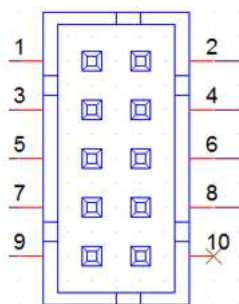

Table A.19: CN14(D),CN10(F),CN7(GH):COM4

Part Number	1655000197
Footprint	WF_5x2P_79_BOX_D_P1R
Description	1655_WF_5x2P_79_BOX_D_P1R_0.Normal
Pin	Pin name
1	DCD
2	RXD
3	TXD
4	DTR#
5	GND
6	DSR#
7	RTS#
8	CTS#
9	RI#

**Table A.20: CN15(D) ,CN12(F),CN9(G),CN96(H):COM3**

Part Number	1655000197
Footprint	WF_5x2P_79_BOX_D_P1R
Description	1655_WF_5x2P_79_BOX_D_P1R_0.Normal
Pin	Pin name
1	DCD
2	RXD
3	TXD
4	DTR#
5	GND
6	DSR#
7	RTS#
8	CTS#
9	RI#

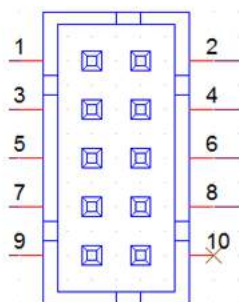
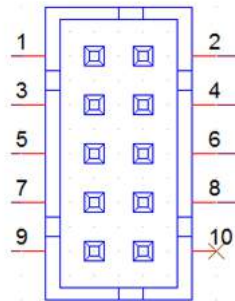

Table A.21: CN11(E):CSAFE

Part Number	1655000197
Footprint	WF_5x2P_79_BOX_D_P1R
Description	1655_WF_5x2P_79_BOX_D_P1R_0.Normal
Pin	Pin name
1	LINE_IN1_L
2	LINIE_IN1_R
3	COM3_RX+
4	COM3_TX
5	V_CSAFE
6	COM3_CTS#
7	GND
8	GND
9	

**Table A.22: CN16(D),CN13(E),CN14(F),CN11(G),CN44(H):COM2**

Part Number	1655000197
Footprint	WF_5x2P_79_BOX_D_P1R
Description	1655_WF_5x2P_79_BOX_D_P1R_0.Normal
Pin	Pin name
1	422/485 TX-
2	422/485 TX+
3	422 RX+
4	422 RX-
5	GND
6	DSR#
7	RTS#
8	CTS#
9	RI#

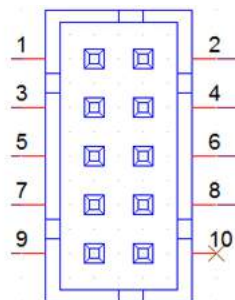
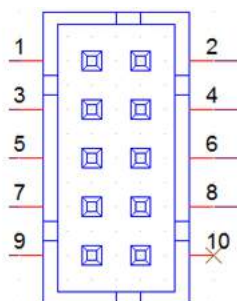

Table A.23: CN18(D),CN14(E),CN15(F),CN13(GH):COM1

Part Number	1655000197
Footprint	WF_5x2P_79_BOX_D_P1R
Description	1655_WF_5x2P_79_BOX_D_P1R_0.Normal
Pin	Pin name
1	DCD
2	RXD
3	TXD
4	DTR#
5	GND
6	DSR#
7	RTS#
8	CTS#
9	RI#

**Table A.24: CN21(D),CN16(EF),CN23(G),CN45(H):Power on Switch**

Part Number	1655302020
Footprint	WF_2P_79_BOX_R1_D
Description	WAFER BOX 2P 2.0mm 180D(M) DIP A2001WV2-2P
Pin	Pin name
1	PSIN
2	GND



Table A.25: CN22(D),CN15(E),CN16(FG),CN168(H):SPEAKER

Part Number	1655304020
Footprint	WF_4P_79_BOX_R1_D
Description	WAFER BOX 2.0mm 4P 180D(M) W/LOCK A2001WV2-4P
Pin	Pin name
1	AUD_OUTA-
2	AUD_OUTA+
3	AUD_OUTB+
4	AUD_OUTB-

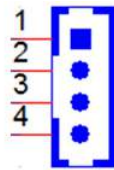
**Table A.26: M.2_1(G):M.2_2230**

Part Number	1654012663-01
Footprint	NGFF_75P_APCI0163-P001A
Description	NGFF 75P 0.5mm 90D(F) H=8.5mm SMD APCI0163-P001A
Pin	Pin name
1,7,33,39,45,51	GND
18,57,63,69,75	GND
3	USB_D+
2,4,72,74	3.3V
5	USB_D-
35	PCIE_TX+
37	PCIE_TX-
41	PCIE_RX-
43	PCIE_RX+
47	CLK_100M+
49	CLK_100M-
55	PCIE_WAKE#
9,11,13,15,17,19,21,23	NC
61,63,65,67,71,73	NC
6,8,10,12,14,16,20,22	NC
32,34,36,38,40,42,44	NC
46,48,58,60,62,64,66	NC
68,70	NC



Table A.27: CN16(H):M.2_2230

Part Number	1654013690-01
Footprint	NGFF_75P_APCI0085-P003A
Description	NGFF 75P/0.5/F/LCP+40GF/RA/G10u/S/BK/H3.0/E Key
Pin	Pin name
1,7,18,33,39,45	GND
51,57,63,69,75,H4	GND
57,71,73,75,H3,H4	GND
2,4,72,74	3.3V
50	SUSCLK_z_EKEY
54	BT_DISABLE#
56	WIFI_DISABLE#
58	I2C0_KEYE_DAT
60	I2C0_KEYE_CLK
3	USB8_z_P+
5	USB8_z_P-
35	PCIE_M2_z_TX7+
37	PCIE_M2_z_TX7-
47	CLK_M2E_z_PCIE+
49	CLK_M2E_z_PCIE-
53	PCIE_a_CLKREQ2#

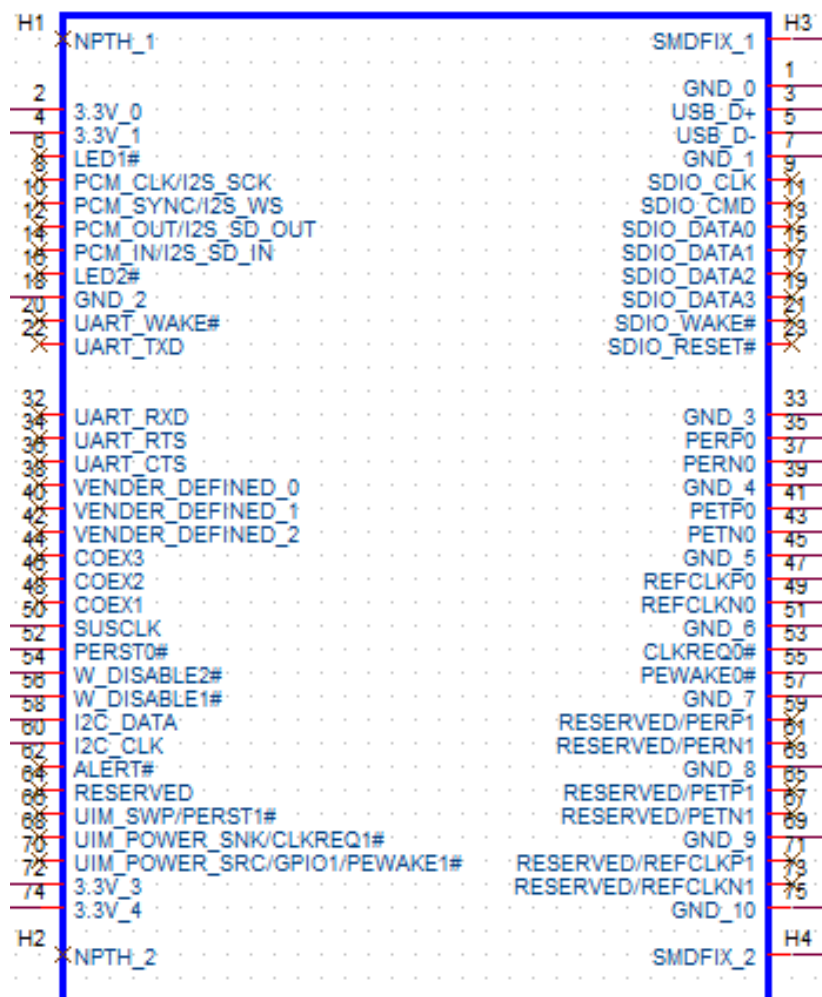

Table A.28: M2M1(H):M.2_2280	
Part Number	1654012187-02
Footprint	NGFF_75P_AS0BC21-S85BM-7H
Description	NGFF 75P 0.5mm 90D(F) H=8.5mm SMD 2E0BC21-S85BM-7H
Pin	Pin name
1,3,9,15,21,27	GND
33,39,45,51	GND
57,71,73,75,H4	GND
5,17,29,41	PERN
7,19,31,43	PERP
11,23,35,47	PETN
13,25,37,49	PETP
2,4,12,14,16	3.3V
18,70,72,74	3.3V
49	SATA1_C_TX+
47	SATA1_C_TX-
43	SATA1_C_RX-
41	SATA1_C_RX+
55	CLK5_M2M+
53	CLK5_M2M-
50	M2_2280_RST#
52	M2_2280_CLKREQ#
54	M2_2280_WAKE#
68	CLK32K_M2_2280
6,8,20,22,24,26	NC
28,30,32,34,36	NC
40,42,44,46	NC
48,56,58	NC

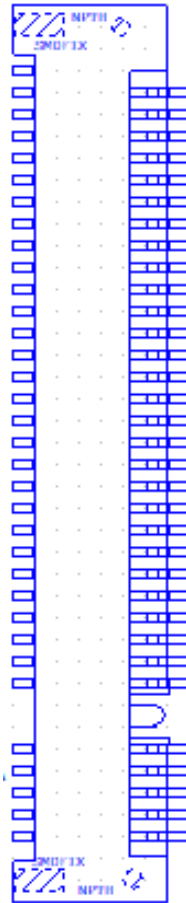

Table A.29: CN23(D),CN17(EFG):LAN1/LAN2

Part Number	1652003274
Footprint	RJ45_28P_RTB-19GB9J1A
Description	PHONE JACK RJ45 28P DIP RTB-19GB9J1A
Pin	Pin name

Table A.30: CN11(H):LAN1/LAN2

Part Number	1652006625-01
Footprint	RJ45_28P_RTB-19GB9J4A
Description	PHONE JACK RJ45 28P 2.54mm DIP RTB-19GB9J4A
Pin	Pin name

Table A.31: CN19(EF),CN21(G):External USB

Part Number	1654010969-01
Footprint	USB_9x2P_UEA1112C-8HS6-4F
Description	USB CONN. 18P 2.0mm 90D(F) DIP UEA1112C
Pin	Pin name
1	+5V
2	D-
3	D+
4	GND
5	RX_D-
6	RX_D+
7	GND
8	TX_D-
9	TX_D+
10	+5V
11	D-
12	D+
13	GND
14	RX_D-
15	RX_D+
16	GND
17	TX_D-
18	TX_D+

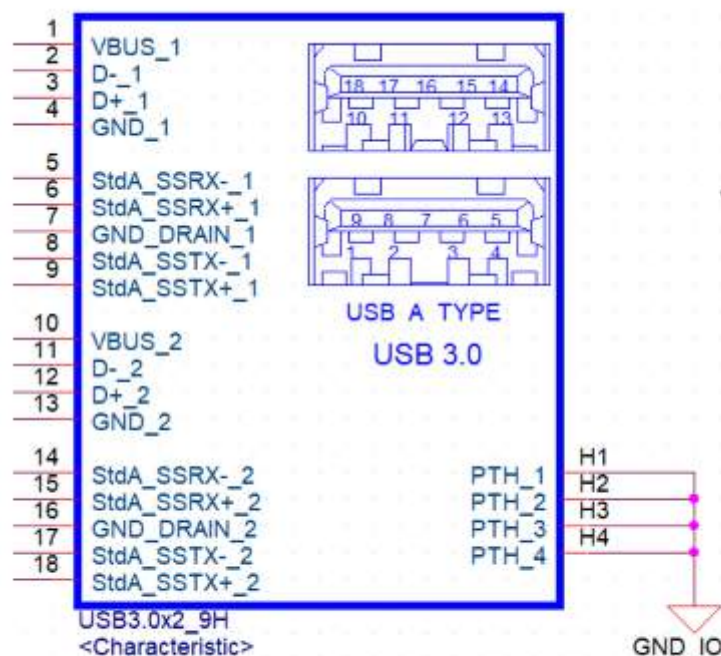

Table A.32: CN20(EF),CN22(G):External USB

Part Number	1654010969-01
Footprint	USB_9x2P_UEA1112C-8HS6-4F
Description	USB CONN. 18P 2.0mm 90D(F) DIP UEA1112C
Pin	Pin name
1	+5V
2	D-
3	D+
4	GND
5	RX_D-
6	RX_D+
7	GND
8	TX_D-
9	TX_D+
10	+5V
11	D-
12	D+
13	GND
14	RX_D-
15	RX_D+
16	GND
17	TX_D-
18	TX_D+

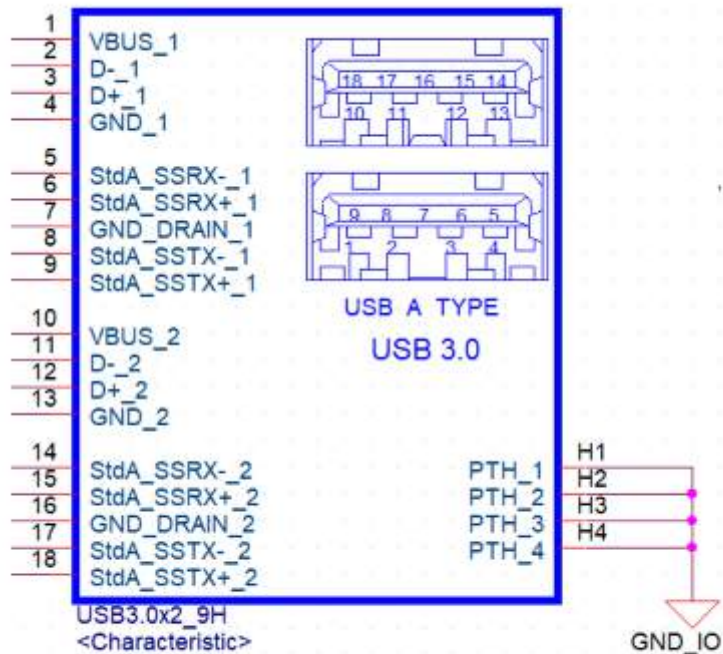

Table A.33: CN24,CN25 (D),CN18(EF),CN20(G):External USB

Part Number	1654009513
Footprint	USB_8P_UB1112C-8FDE-4F
Description	USB CONN. 8P 2.0mm 90D DIP UB1112C-8FDE-4F
Pin	Pin name
1	+5VSB
2	D-
3	D+
4	GND
5	+5VSB
6	D-
7	D+
8	GND

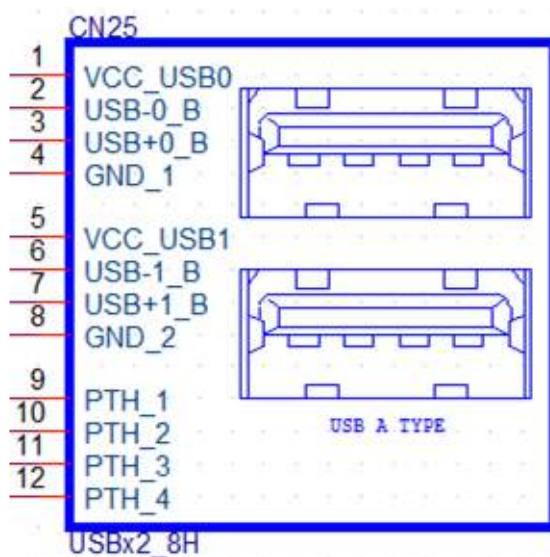

Table A.34: CN26(D):External USB

Part Number	1654010199
Footprint	USB_13P_UEA1112C-UHS6-4F
Description	USB Conn. 2.0+3.0 13P 90D(F) DIP UEA1112C-UHS6-4
Pin	Pin name
1	+5VSB
2	D0-
3	D0+
4	GND
5	RX_D-
6	RX_D+
7	GND
8	TX_D-
9	TX_D+
10	+5VSB
11	D1-
12	D1+
13	GND

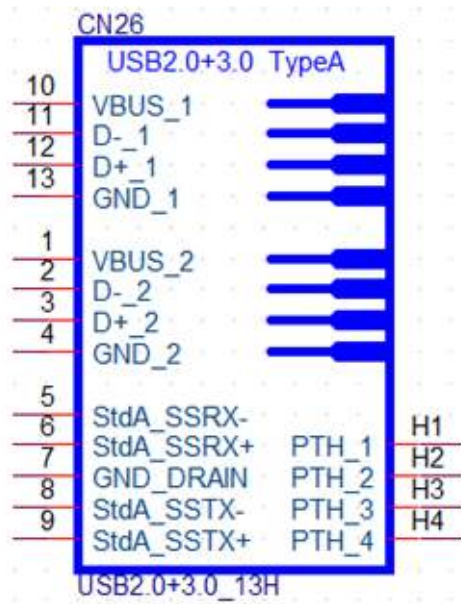

Table A.35: CN170(H),CN169(H),CN43(H):External USB

Part Number	1654013480-01
Footprint	USB_9x2P_USB5-18F5-BNR0-10
Description	USB 3.1 2x9P/2.0mm/PA66/(F)/RA/G30u/D/BU/H15.69
Pin	Pin name
1	+5V
2	D5-
3	D5+
4	GND
5	RX-
6	RX+
7	GND
8	TX-
9	TX+
10	+5V
11	D6-
12	D6+
13	GND
14	RX-
15	RX+
16	GND
17	TX-
18	TX+

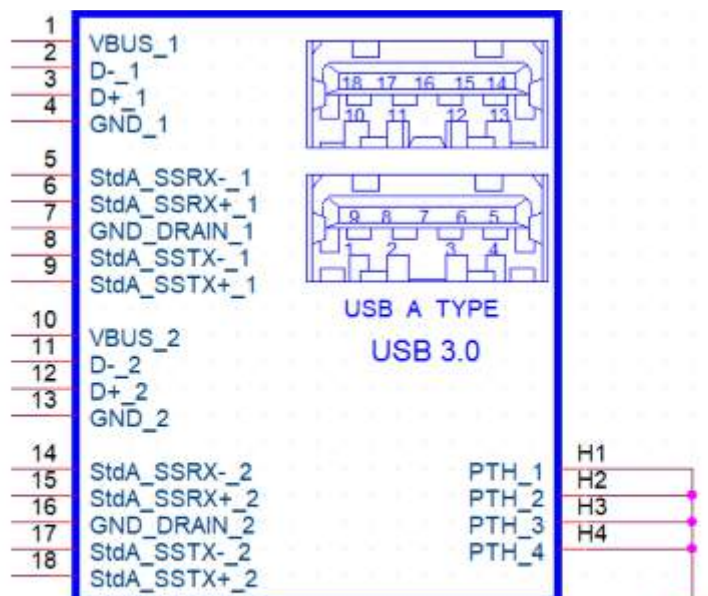

Table A.36: CN27(D),CN21(E),CN22(F),CN25(G),CN66(H):Line-out

Part Number	1652001586
Footprint	KUONYI_PJ-2508PC-5-L
Description	PHONE JACK 5P 3.5φ 90D(F) AZALIA GREEN DIP WO/P
Pin	Pin name
1	GND
2	OUT_L
3	JD
4	OUT_R
5	GND

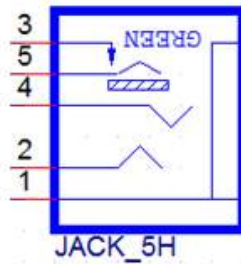

Table A.37: CN28(D),CN22(E),CN21(F),CN24(GH):MIC-IN

Part Number	1652001584
Footprint	KUONYI_PJ-2508PA-5-L
Description	PHONE JACK 5P 3.5φ 90D(F) AZALIA PINK DIP WO/Pb
Pin	Pin name
1	GND
2	MIC_L
3	JD
4	MIC_R
5	GND

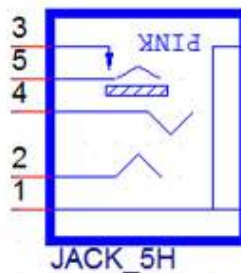

Table A.38: CN30(D),CN24(EF),CN27(G),CN15(H):HDMI	
Part Number	1654011175-01
Footprint	HDMI_19P_QJ51191-LFB4-7F
Description	HDMI Conn. 19P 0.5mm 90D(F) SMD QJ51191-LFB4-7F
Pin	Pin name
1	HDMI_TX0+
2	GND
3	HDMI_TX0-
4	HDMI_TX1+
5	GND
6	HDMI_TX1-
7	HDMI_TX2+
8	GND
9	HDMI_TX2-
10	HDMI_TX3+
11	GND
12	HDMI_TX3-
13	NC
14	NC
15	HDMI_CLK
16	HDMI_DAT
17	GND
18	+5V
19	HDMI_DET

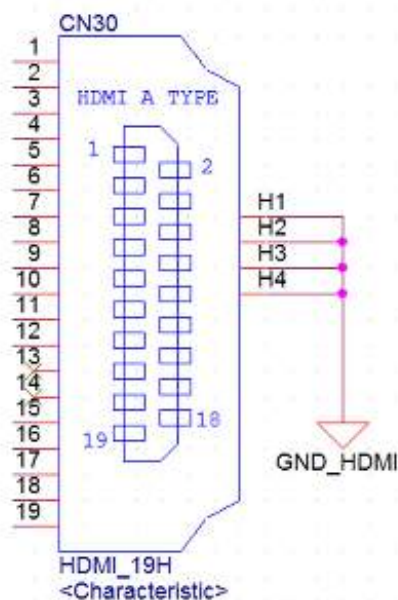

Table A.39: CN42(H):DP

Part Number	1654006275
Footprint	DPCON_20P_3VD11203-H7A0-4H
Description	DisplayPort Conn. 20P 1.40mm 90D DIP 3VD11203
Pin	Pin name
2,5,8,11,14,16,19	GND
1	DP_TX0+
3	DP_TX0-
4	DP_TX1+
6	DP_TX1-
7	DP_TX2+
9	DP_TX2-
10	DP_TX3+
12	DP_TX3-
13	DP_AUX_EN#
15	DP1_AUX+
17	DP1_AUX-
18	DDP2_DP_HPD
20	3.3V

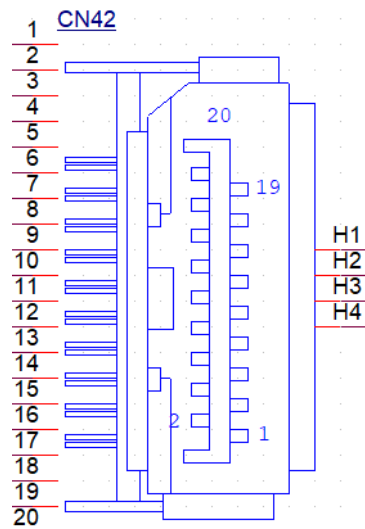

Table A.40: CN31(DG),CN25(EF),DCIN1(H):DC-IN

Part Number	1652005624
Footprint	PJ_2P_2DC-G213B200
Description	DC POWER JACK 2.5mm 90D(M) DIP 2DC-G213B200
Pin	Pin name
1	DC_IN
2	GND

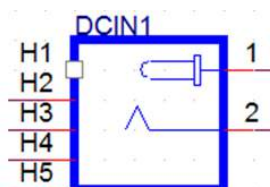

Table A.41: CN29(D),CN23(EF),CN26(G):RJ11

Part Number	1652005977-02
Footprint	S RJ11_6P_RJ1201-66N024R0
Description	PHONE JACK RJ11 6P6C 90D(F) DIP 6u RJ1201-66N024
Pin	Pin name
1	GND
2	Drawer_A
3	Drawer_state
4	Power
5	Drawer_B
6	GND

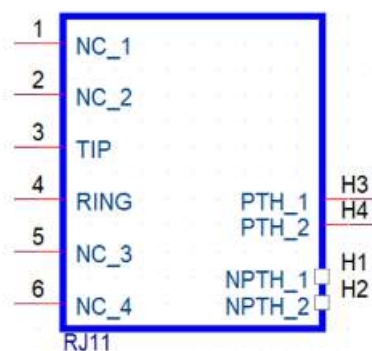
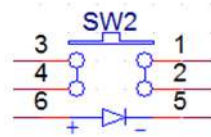
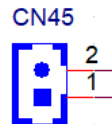

Table A.42: BUTTON:Power Button

Part Number	1600000055
Footprint	SW_6P_TC003-N11AABRGXX-RK_D
Description	PUSH SW DIP 6P W/LED WO/Pb TC003-N11AABRGXX-RK
Pin	Pin name
1	GND
2	GND
3	ATX_PWRBTN#
4	ATX_PWRBTN#
5	+5V
6	GND

**Table A.43: CN45(H):Power Button**

Part Number	1655302020
Footprint	WF_2P_79_BOX_R1_D
Description	WAFER BOX 2P 2.0mm 180D(M) DIP A2001WV2-2P
Pin	Pin name
1	GND
2	ATX_PWRBTN#

**Table A.44: SW5(H):Power Button**

Part Number	1600002384
Footprint	SW_2P_EL TSA-63_D
Description	PUSH SW EL TSA-63N-H DIP 4P 7.4x6.65x8.5mm
Pin	Pin name
1	ATX_PWRBTN#
2	GND
3	GND
4	GND

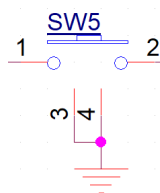

ADVANTECH

Enabling an Intelligent Planet

www.advantech.com

Please verify specifications before quoting. This guide is intended for reference purposes only.

All product specifications are subject to change without notice.

No part of this publication may be reproduced in any form or by any means, electronic, photocopying, recording or otherwise, without prior written permission of the publisher.

All brand and product names are trademarks or registered trademarks of their respective companies.

© Advantech Co., Ltd. 2021